

JVC



AUDIO/VIDEO CONTROL RECEIVER

RX-9000VBK

K2
INTERFACE

DIGITAL AP

Dynamic **SUPER-A**

TEXT
COMPU LINK

AV COMPU LINK

COMPU LINK
Remote

3D
3D-PHONIC

DIGITAL
dts
SURROUND

DOLBY
DIGITAL

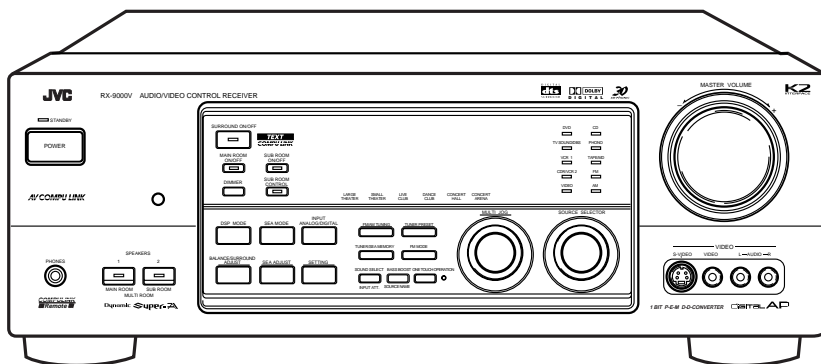
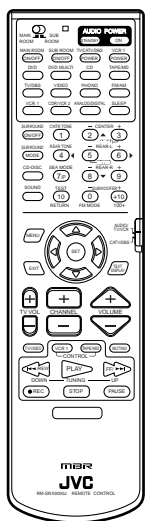

INSTRUCTIONS

For Customer Use:

Enter below the Model No. and Serial No. which are located either on the rear, bottom or side of the cabinet. Retain this information for future reference.

Model No. _____

Serial No. _____

Warnings, Cautions and Others

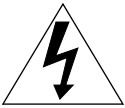
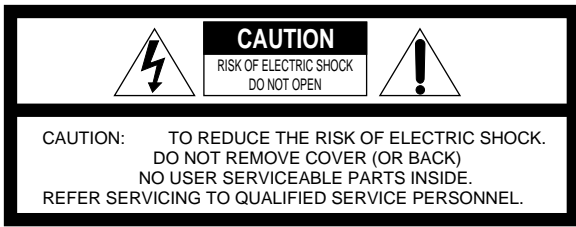

The lightning flash with arrowhead symbol, within an equilateral triangle is intended to alert the user to the presence of uninsulated "dangerous voltage" within the product's enclosure that may be of sufficient magnitude to constitute a risk of electric shock to persons.



The exclamation point within an equilateral triangle is intended to alert the user to the presence of important operating and maintenance (servicing) instructions in the literature accompanying the appliance.

WARNING: TO REDUCE THE RISK OF FIRE OR ELECTRIC SHOCK, DO NOT EXPOSE THIS APPLIANCE TO RAIN OR MOISTURE.

CAUTION

To reduce the risk of electrical shocks, fire, etc.:

1. Do not remove screws, covers or cabinet.
2. Do not expose this appliance to rain or moisture.

Caution — POWER switch!

Disconnect the mains plug to shut the power off completely. The POWER switch in any position does not disconnect the mains line. The power can be remote controlled.

Caution — SPEAKER LOAD SELECTOR switch!

Match the position of SPEAKER LOAD SELECTOR switch on the back panel to the impedance of the speaker connected, to protect from overheating.

For the main unit:

Declaration of Conformity

Model Number: RX-9000VBK

Trade Name: JVC

Responsible Party: JVC Americas Corp.

Address: 1700 Valley Road, Wayne

New Jersey 07470

Telephone Number: 973-315-5000

This device complies with Part 15 of FCC Rules. Operation is subject to the following two conditions: (1) This device may not cause harmful interference, and (2) this device must accept any interference received, including interference that may cause undesired operation.

For the main unit:

This equipment has been tested and found to comply with the limits for a Class B digital device, pursuant to part 15 of the FCC Rules. These limits are designed to provide reasonable protection against harmful interference in a residential installation.

This equipment generates, uses and can radiate radio frequency energy and, if not installed and used in accordance with the instructions, may cause harmful interference to radio communications. However, there is no guarantee that interference will not occur in a particular installation. If this equipment does cause harmful interference to radio or television reception, which can be determined by turning the equipment off and on, the user is encouraged to try to correct the interference by one or more of the following measures:

Reorient or relocate the receiving antenna.

Increase the separation between the equipment and receiver.

Connect the equipment into an outlet on a circuit different from that to which the receiver is connected.

Consult the dealer or an experienced radio/TV technician for help.

Changes or modifications not expressly approved by the manufacturer for compliance could void the user's authority to operate the equipment.

For the remote control:

This device complies with Part 15 of the FCC Rules. Operation is subject to the following two conditions: (1) This device may not cause harmful interference, and (2) this device must accept any interference received, including interference that may cause undesired operation.

Changes or modifications not expressly approved by the manufacturer for compliance could void the user's authority to operate the equipment.

Caution: Proper Ventilation

To avoid risk of electric shock and fire and to protect from damage.

Locate the apparatus as follows:

- Front: No obstructions open spacing.
Sides: No obstructions in 10 cm from the sides.
Top: No obstructions in 10 cm from the top.
Back: No obstructions in 15 cm from the back
Bottom: No obstructions, place on the level surface.

In addition, maintain the best possible air circulation as illustrated.

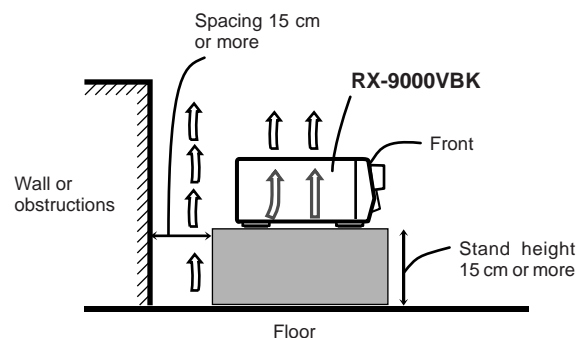

Table of Contents

Introduction	2	Receiving Radio Broadcasts	29
Features	2	Tuning in Stations Manually	29
Precautions	2	Using Preset Tuning	29
Parts Identification	3	Selecting the FM Reception Mode	30
Getting Started	4	Assigning Names to Preset Stations	30
Before Installation	4	Using the SEA Modes	31
Checking the Supplied Accessories	4	Selecting Your Favorite SEA Mode	31
Connecting the FM and AM Antennas	4	Creating Your Own SEA Mode	31
Connecting the Speakers	5	Using the DSP Modes	32
Connecting Audio/Video Components	6	What are the DSP Modes?	32
Setting Up the RF Rod Antenna	10	Reproducing the Sound Field	33
Setting Up the IR Signal Transmitter	10	Available DSP Modes According to the Speaker Arrangement	34
Putting Batteries in the Remote Control	11	Adjusting the Surround Modes	35
Connecting the Power Cord	11	Adjusting the DAP Modes	38
Multi-room Operations	12	Activating the DSP Modes	40
Basic Operating Procedure for Main Room	13	Using the DVD MULTI Playback Mode	41
Basic Operating Procedure for Sub-Room	14	Activating the DVD MULTI Playback Mode	41
Main Room Basic Operations	15	Using the On-Screen Menus	42
Turning the Power On and Off (Standby)	15	■ Selecting the Main Room Source to Play	42
Canceling the Main Room Operations	15	■ Selecting Different Sources for Picture and Sound	42
Selecting the Main Room Source to Play	16	■ Activating the DSP Modes	42
Adjusting the Main Room Volume	17	■ Selecting the Analog or Digital Input Mode	42
Activating the Main Room Front Speakers	17	■ Adjusting the Front Speaker Output Balance	43
Muting the Main Room Sound	18	■ Reinforcing the Bass	43
Reinforcing the Bass	18	■ Attenuating the Input Signal	43
Attenuating the Input Signal	18	■ Adjusting the Subwoofer Output Level	43
Adjusting the Subwoofer Output Level	18	■ Adjusting the DSP Modes	43
Adjusting the Front Speaker Output Balance	19	■ Adjusting the DVD MULTI Playback Mode	44
Using the Sleep Timer	19	■ Selecting Your Favorite SEA Mode	45
Changing the Display Brightness	19	■ Creating Your Own SEA Mode	45
Recording a Source	19	■ Setting the Basic Setting Items	45
Sub-Room Operations	20	■ Operating the Tuner	46
Turning the Power On and Off (Standby) and Selecting		■ Storing the Preset Stations	46
the Sub-room Operations	20	■ Assigning Names to Preset Stations	46
Canceling the Sub-room Operations	21	COMPU LINK Remote Control System	47
Selecting the Sub-room Source to Play	21	TEXT COMPU LINK Remote Control System ..	49
Adjusting the Sub-room Volume	22	■ Showing the Disc Information on the TV Screen	50
Activating the Sub-room Front Speakers	22	■ Searching for a Disc (Only for the CD player)	51
Muting the Sub-room Sound	22	■ Entering the Disc Information	52
Operating the Playback Source for the Sub-room	22	AV COMPU LINK Remote Control System	54
Basic Settings	23	Operating JVC's Audio/Video Components ...	57
Changing the Source Name	23	Operating Other Manufacturers' Video	
Setting the Front Speakers Either for the Main Room		Equipment	60
or Sub-room	23	Troubleshooting	63
Setting the Subwoofer Information	23	Specifications	65
Setting the Speakers for the DSP Modes	24		
Digital Input (DIGITAL IN) Terminal Setting	26		
Selecting the Analog or Digital Input Mode	26		
Showing the Text Information on the Display	27		
Storing the Basic Settings and Adjustments — One Touch			
Operation	28		



Indicates the functions YOU CAN ALSO USE when the receiver is ready for the sub-room operations.

Introduction

*We would like to thank you for purchasing one of our JVC products.
Before operating this unit, read this manual carefully and thoroughly to obtain the best possible performance
from your unit, and retain this manual for future reference.*

Features

Main Functions

• **Dolby Digital Decoder Incorporated**

You can enjoy Dolby Digital, one of the most advanced home theater sound systems available. Dolby Digital, with five full-range channels and a subwoofer channel, lets you enjoy the most spectacular theater sound at home when you view movies on DVD.

• **Compatible with DTS Digital Surround**

The RX-9000VBK is compatible with DTS Digital Surround as well. DTS Digital Surround is the latest digital movie soundtrack format that delivers 5.1-channel audio like Dolby Digital. Using a low audio-data compression rate, it features natural, solid and clear sound.

• **Multi Room Operations**

You can connect two pairs of the front speakers to the RX-9000VBK, and use them to listen to different sources in the different rooms (Main room and Sub-room) at the same time.

• **RF/IR Multi-brand Remote Control**

The remote control sends out not only IR (infrared) signals but also RF (radio frequency) signals as coded commands to control the receiver. The RF rod antenna can receive the RF (Radio Frequency) signals sent from the remote control to operate the receiver. In addition, the supplied RF signal transmitter can transmit IR signals which could control other video components.

- The remote control provided with this receiver can transmit control signals for many manufacturers' video components.

• **COMPU LINK Remote Control System**

The COMPU LINK remote control system allows you to operate other JVC audio components from this receiver.

• **TEXT COMPU LINK Remote Control System**

The TEXT COMPU LINK remote control system has been developed to deal with the disc information recorded in the CD Text and MDs. Using these information in the discs, you can operate the CD player or MD recorder through the receiver.

• **AV COMPU LINK Remote Control System**

The AV COMPU LINK remote control system allows you to operate other JVC video components from this receiver.

Main Technologies

• **K2 Interface**

K2 Interface eliminates jitter and ripples, achieving a drastic reduction in digital distortion. You can obtain a natural sound field from stereo and 5.1 channel sources.

• **Dynamic Super-A**

Dynamic Super-A is JVC's exclusive technology which combines the silky, distortion-free sound of a class-A amplifier and the robust efficiency of a class-B amplifier.

Precautions

Power sources

- When unplugging the receiver from the wall outlet, always pull the plug, not the AC power cord.
- Do not handle the AC power cord with wet hands.
- If you are not going to operate the receiver for an extended period of time, unplug the AC power cord from the wall outlet.

Multi-room operations

- Do not use the remote control outdoors or install the speakers outdoors.
- When operating the receiver from the place where you cannot see the receiver (for example, when controlling the receiver installed in the living room, from the kitchen), pay attention to the following not to surprise other people:
 - Be careful not to turn up the volume so high when controlling the receiver without listening to the playback sound.
 - Be careful not to surprise other people at a sudden sound coming out of the receiver when turning it on. (A sudden stop of the sound may also surprise other people.)
- If the receiver operates by itself or malfunctions, the following causes will be considered.
 - Interference to RF communication between the receiver and the remote control from outside.
 - The remote control is operated unintentionally. For example, a book is placed on the remote control, possibly, depressing some buttons on the remote control.
- If your neighbour uses the same or similar RF remote control system, the receiver may happen to receive the RF signals sent from such an RF remote control system, which could cause your receiver to be operated unintentionally. If this happen, stop using the RF rod antenna and the remote control, and consult your JVC dealer or the nearest JVC Service Center.

Others

- Should any metallic object or liquid fall into the unit, unplug the unit and consult your dealer before operating any further.
- Do not disassemble the unit since there are no user serviceable parts inside.

If anything goes wrong, unplug the AC power cord and consult your JVC dealer.

Parts Identification

Refer to the pages in parentheses for details.

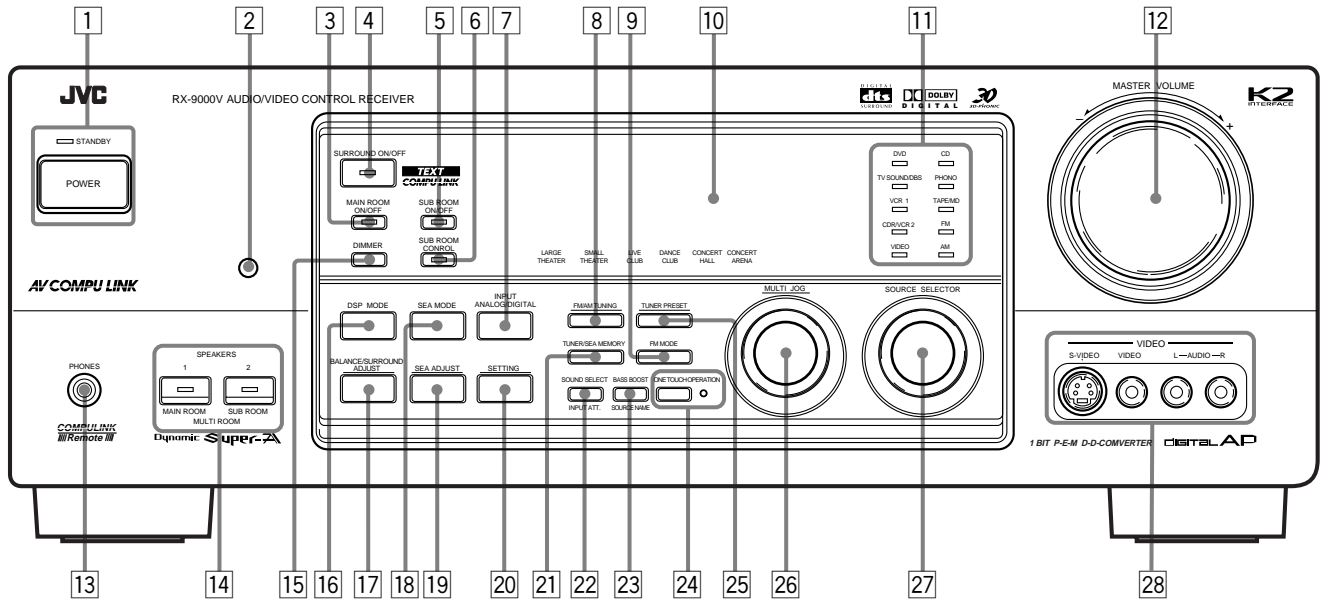

Remote Control

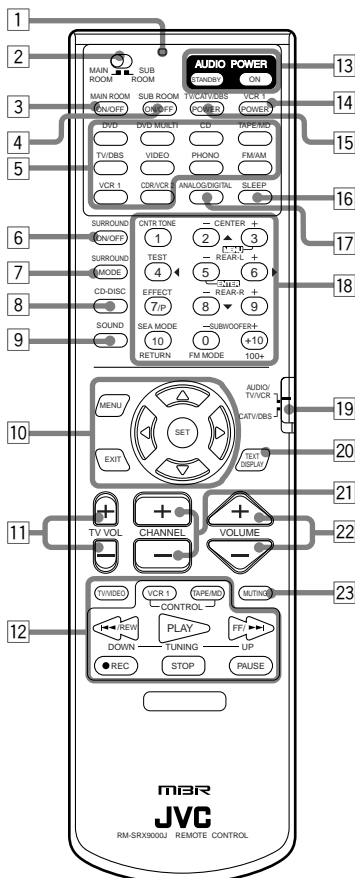

- 1 Remote operation lamp (10)
Lights when transmitting a control signal.
- 2 Multi-room operation selector (13, 14)
- 3 MAIN ROOM ON/OFF button (15)
- 4 SUB ROOM ON/OFF button (14, 20)
- 5 Source selecting buttons (16, 21)
DVD, DVD MULTI, CD, TAPE/MD, TV/DBS, VIDEO, PHONO, FM/AM, VCR 1, CDR/VCR 2
- 6 SURROUND ON/OFF button (35, 40)
- 7 SURROUND MODE button (37, 39, 40)
- 8 CD-DISC button (58)
- 9 SOUND button (18, 31, 35, 39, 41)
- 10 On-screen operation buttons (42, 50)
MENU, SET, EXIT, Δ , ∇ , \triangleleft , \triangleright
- 11 TV VOL +/- buttons (59, 60)
- 12 Operating buttons for audio/video components (57 - 61)
- 13 AUDIO POWER buttons (13 - 15, 20)
STANDBY, ON
- 14 VCR 1 POWER button (59, 61)
- 15 TV/CATV/DBS POWER button (59 - 61)
- 16 SLEEP button (19)
- 17 ANALOG/DIGITAL button (27)
- 18 • 10 keys for selecting preset channels (30)
• 10 keys for adjusting sound (18, 31, 35, 39, 41)
• 10 keys for operating audio/video components (57 - 61)
- 19 Remote control mode selector (15, 57, 59, 60)
- 20 TEXT DISPLAY button (50)
- 21 CHANNEL +/- button (59 - 61)
- 22 VOLUME +/- button (13, 14, 17, 22)
- 23 MUTING button (18, 22)

Front Panel

- 1 POWER button and STANDBY lamp (13 - 15, 20)
- 2 Remote sensor (10)
- 3 MAIN ROOM ON/OFF button and lamp (15)
- 4 SURROUND ON/OFF button and lamp (36, 40)
- 5 SUB ROOM ON/OFF button and lamp (14, 20)
- 6 SUB ROOM CONTROL button and lamp (14, 21)
- 7 INPUT ANALOG/DIGITAL button (27)
- 8 FM/AM TUNING button (29) *
- 9 FM MODE button (30)
- 10 Display (16)
- 11 Source lamps (16)
- 12 MASTER VOLUME control (13, 14, 17, 22)
- 13 PHONES jack (17)
- 14 Front speaker buttons and lamps
• SPEAKERS 1, SPEAKERS 2 (17)
• MAIN ROOM, SUB ROOM (22)
- 15 DIMMER button (19)
- 16 DSP MODE button (36, 38, 40)
- 17 BALANCE/SURROUND ADJUST button (19, 36, 37) *
- 18 SEA MODE button (31)
- 19 SEA ADJUST button (31) *
- 20 SETTING button (23 - 27) *
- 21 TUNER/SEA MEMORY button (29 - 31)
- 22 SOUND SELECT/INPUT ATT. button (17, 18)
- 23 BASS BOOST/SOURCE NAME button (18, 23)
- 24 ONE TOUCH OPERATION button and lamp (28)
- 25 TUNER PRESET button (30) *
- 26 MULTI JOG control
What this control actually does depends on which function you are trying to adjust. Before using this control, select the function by pressing one of the buttons marked with *.
- 27 SOURCE SELECTOR control (13, 14, 16, 21)
- 28 VIDEO input jacks (8)

Getting Started

This section explains how to connect audio/video components and speakers to the receiver, and how to connect the power supply.

Before Installation

General

- Be sure your hands are dry.
- Turn the power off to all components.
- Read the manuals supplied with the components you are going to connect.

Locations

- Install the receiver in a location that is level and protected from moisture.
- The temperature around the receiver must be between -5°C and 35°C (23°F and 95°F).
- Make sure there is good ventilation around the receiver. Poor ventilation could cause overheating and damage the receiver.

Handling the receiver

- Do not insert any metal object into the receiver.
- Do not disassemble the receiver or remove screws, covers, or cabinet.
- Do not expose the receiver to rain or moisture.

Checking the Supplied Accessories

Check to be sure you have all of the following items, which are supplied with the receiver.

The number in the parentheses indicates quantity of the pieces supplied.

- Remote Control (1)
- Batteries (2)
- AM Loop Antenna (1)
- FM Antenna (1)
- RF Rod Antenna (1)
- IR Signal Transmitter (1)

If anything is missing, contact your dealer immediately.

Connecting the FM and AM Antennas

FM Antenna Connections

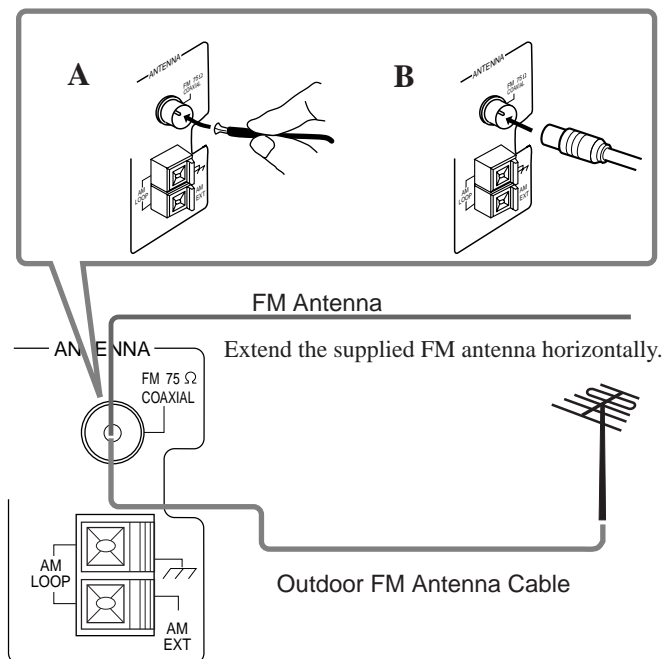

A. Using the Supplied FM Antenna

The FM antenna provided can be connected to the FM 75 Ω COAXIAL terminal as a temporary measure.

B. Using the Standard Type Connector with Outdoor FM Antenna (Not Supplied)

A standard type connector should be connected to the FM 75 Ω COAXIAL terminal.

Note:

If reception is poor, connect the outdoor antenna. Before attaching a 75 Ω coaxial cable (the kind with a round wire going to an outdoor antenna), disconnect the supplied FM antenna.

AM Antenna Connections

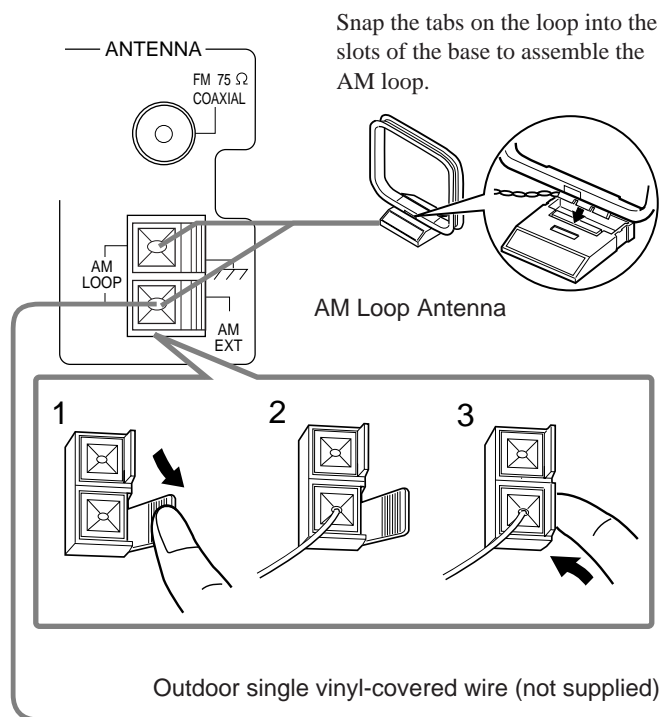

Turn the loop until you have the best reception.

Notes:

- Make sure the antenna conductors do not touch any other terminals, connecting cords and power cord. This could cause poor reception.
- If reception is poor, connect an outdoor single vinyl-covered wire to the AM EXT terminal. (Keep the AM loop antenna connected.)

Connecting the Speakers

You can connect the following speakers:

- Two pairs of front speakers to produce normal stereo sound.
- One pair of rear speakers to enjoy the surround effect.
- One center speaker to produce more effective surround effect (to emphasize human voices).
- One powered subwoofer to enhance the bass.

IMPORTANT:

After connecting the speakers listed above, set the speaker setting information properly:

- To obtain the best possible DSP effect in the main room, see page 24.
- To use the Multi-room function, see “Setting the Front Speakers Either for the Main Room or Sub-room” on page 23.

For each speaker (except for a subwoofer), connect the (-) and (+) terminals on the rear panel to the (-) and (+) terminals marked on the speakers. For connecting a subwoofer, see page 6.

CAUTION:

Use speakers with the SPEAKER IMPEDANCE indicated by the speaker terminals.

Basic connecting procedure

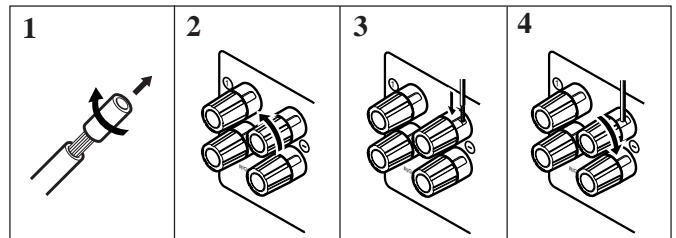

- 1 Cut, twist and remove the insulation at the end of each speaker signal cable (not supplied).
- 2 Turn the knob counterclockwise.
- 3 Insert the speaker signal cable.
- 4 Turn the knob clockwise.

Connecting the front speakers

You can connect two pairs of front speakers — one pair to the FRONT 1 SPEAKERS terminals, and the other pair to the FRONT 2 / SUB ROOM SPEAKERS terminals.

The speakers connected to the FRONT 2 / SUB ROOM SPEAKERS terminals can be used as follows:

- As the second front speakers in the main listening room
- As the main speakers in the sub listening room when using the Multi-room function.

Right speaker — FRONT 1 SPEAKERS — Left speaker

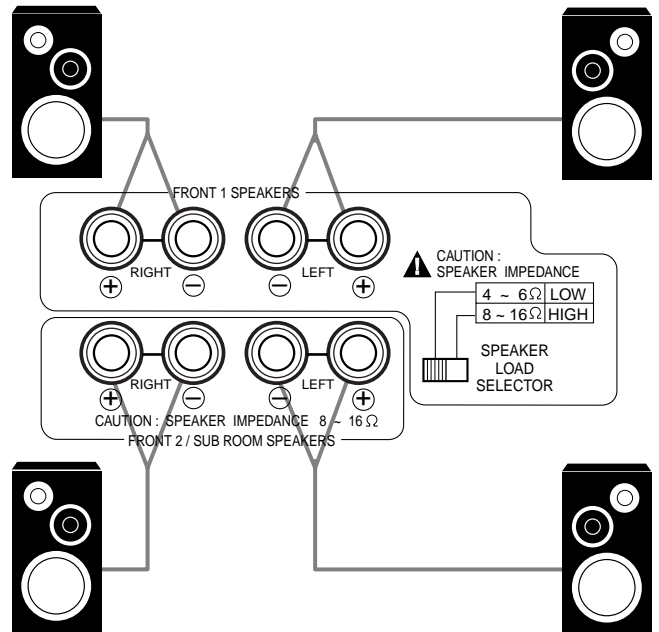

Right speaker — FRONT 2 / SUB ROOM — Left speaker
SPEAKERS

IMPORTANT for FRONT 1 SPEAKERS connection:

To obtain the best possible output power from the receiver, and to prevent the receiver from being overheated, the receiver has the SPEAKER LOAD SELECTOR which has to be set as follows:

- Set it to the HIGH position when the impedance of the front speakers connected is within the range of 8 Ω to 16 Ω.
- Set it to the LOW position when the impedance of the front speakers connected is within the range of 4 Ω to 6 Ω.

Connecting the rear and center speakers

Connect rear speakers to the REAR SPEAKERS terminals and a center speaker to the CENTER SPEAKER terminals.

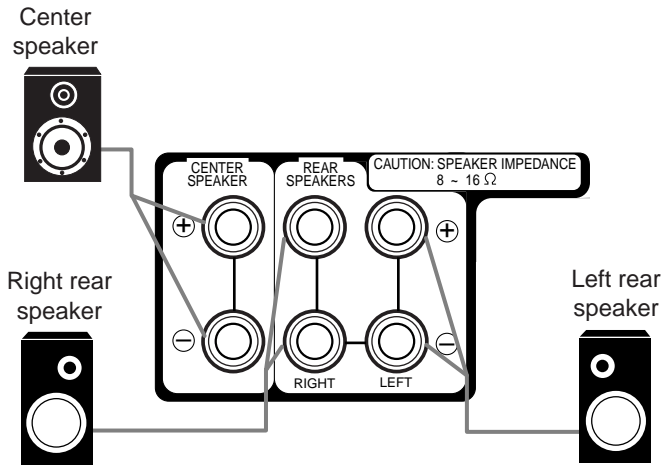

Connecting the subwoofer speaker

You can enhance the bass by connecting a subwoofer. Connect the input jack of a powered subwoofer to the SUBWOOFER OUT jack on the rear panel, using a cable with RCA pin plugs (not supplied).



Powered subwoofer

Connecting Audio/Video Components

You can connect the following audio/video components to this receiver. Refer also to the manuals supplied with your components.

Audio Components	Video Components
• Turntable	• DVD player*
• CD player*	• TV*
• Cassette deck or MD recorder*	• DBS tuner*
• CD recorder*	• VCR(s)
	• Video camera

* You can connect these components using the methods described in "Analog connections" (to the right) or in "Digital connections" (see page 9).

Analog connections

Audio component connections

Use the cables with RCA pin plugs (not supplied).

Connect the white plug to the audio left jack, and the red plug to the audio right jack.

CAUTION:

If you connect a sound-enhancing device such as a graphic equalizer between the source components and this receiver, the sound output through this receiver may be distorted.

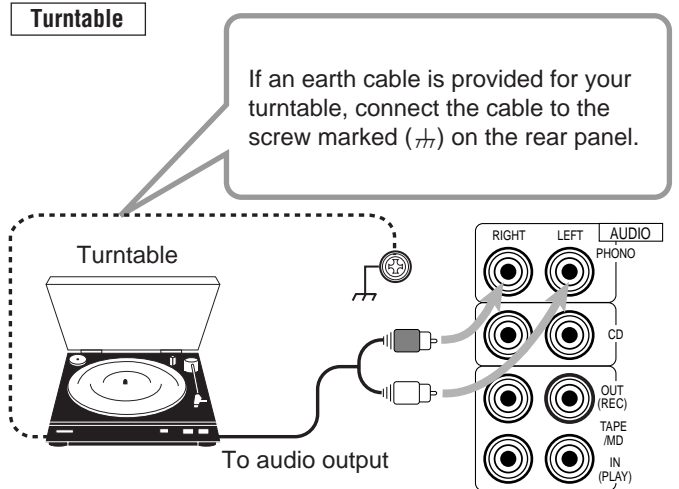

Note:

Any turntables incorporating a small-output cartridge such as an MC (moving-coil) type must be connected to this receiver through a commercial head amplifier or step-up transformer. Direct connection may result in insufficient volume.

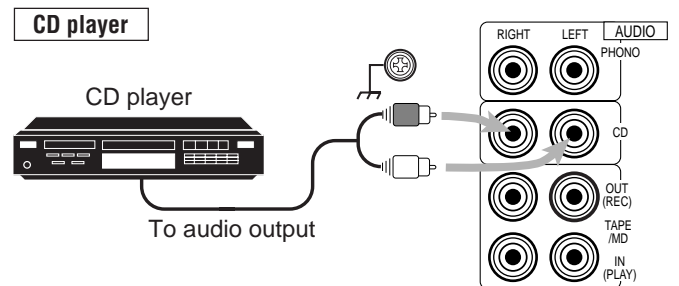

Cassette deck or MD recorder

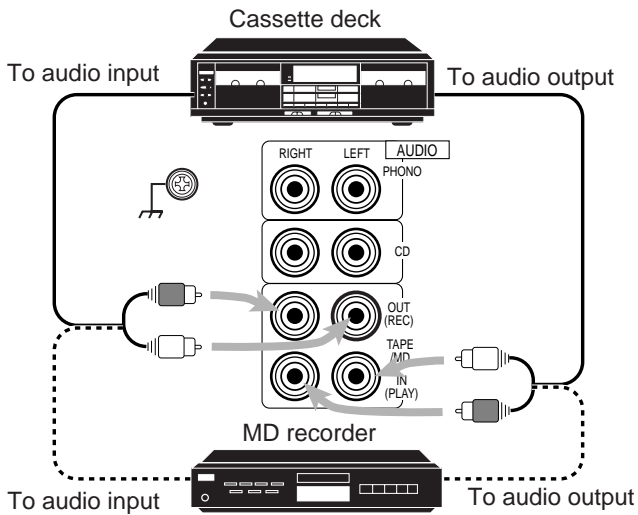

Note:

You can connect either a cassette deck or an MD recorder to the TAPE/MD jacks. When connecting an MD recorder to the TAPE/MD jacks, change the source name, which will be shown on the display when selected as the source, to "MD." See page 23 for details.

CD recorder

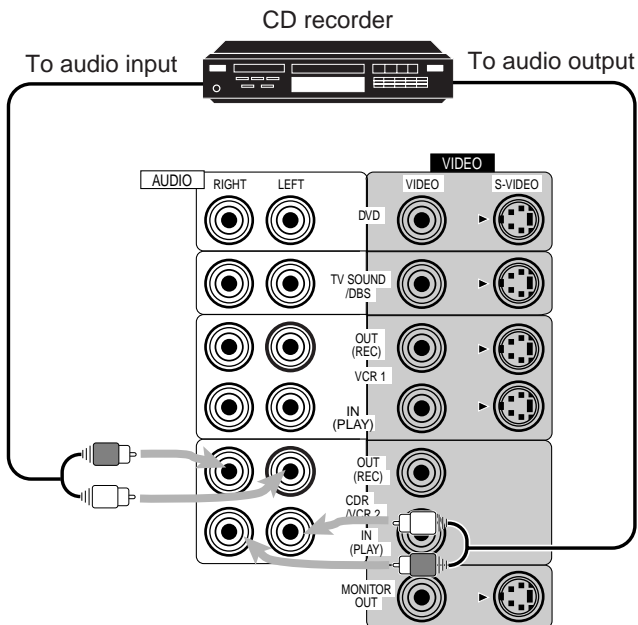

If your audio components have a COMPU LINK or TEXT COMPU LINK jack

- See page 47 for detailed information about the connection and the COMPU LINK remote control system.
- See page 49 for detailed information about the connection and the TEXT COMPU LINK remote control system.

Video component connections

Use the cables with RCA pin plugs (not supplied). Connect the white plug to the audio left jack, the red plug to the audio right jack, and the yellow plug to the video jack. If your video components have S-video (Y/C-separation) terminals, connect them using S-video cables (not supplied). Connecting these video components through the S-video input/output terminals will give you better picture playback (or recording) quality.

IMPORTANT:

This receiver is equipped with both the composite video and S-video input/output terminals for connecting video components. You do not have to connect both the composite video and S-video terminals.

However, **remember that the video signals from the composite video input terminals are output only through the composite video output terminals, while the ones from the S-video input terminals are output only through the S-video output terminals.** Therefore, if a recording video component and a playing video component are connected to the receiver through the different video terminals, you cannot record the picture from the playing component on the recording component. In addition, if the TV and a playing video component are connected to the receiver through the different video terminals, you cannot view the playback picture from the playing component on the TV.

To view and record the playback picture from the video component connected to the CDR/VCR 2 jacks, you must connect the TV and the recording video component through the composite video terminals.

VCR

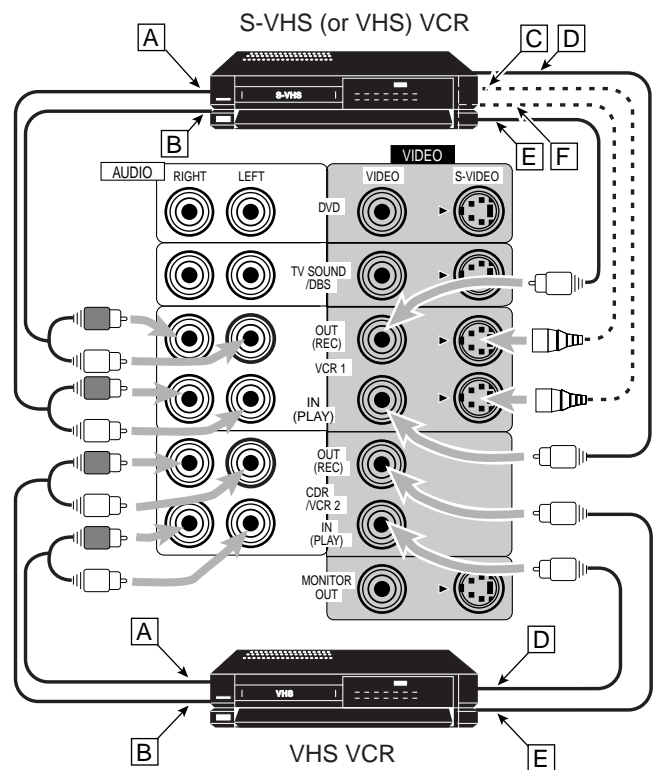

- A To left/right channel audio output
- B To left/right channel audio input
- C To S-video output
- D To composite video output
- E To composite video input
- F To S-video input

Video camera

The VIDEO input jacks on the front panel are convenient when connecting and disconnecting the equipment frequently.

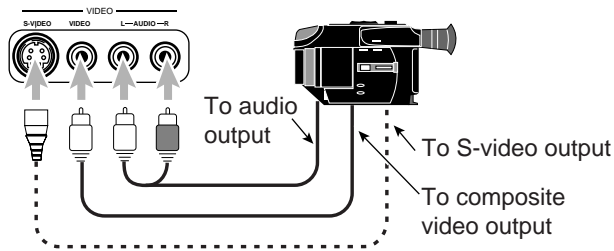

TV and/or DBS tuner

When connecting the TV, DO NOT connect the TV's video output to these video input terminals.

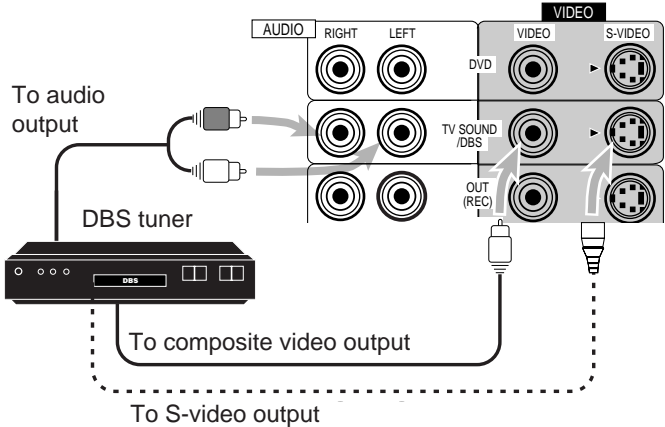
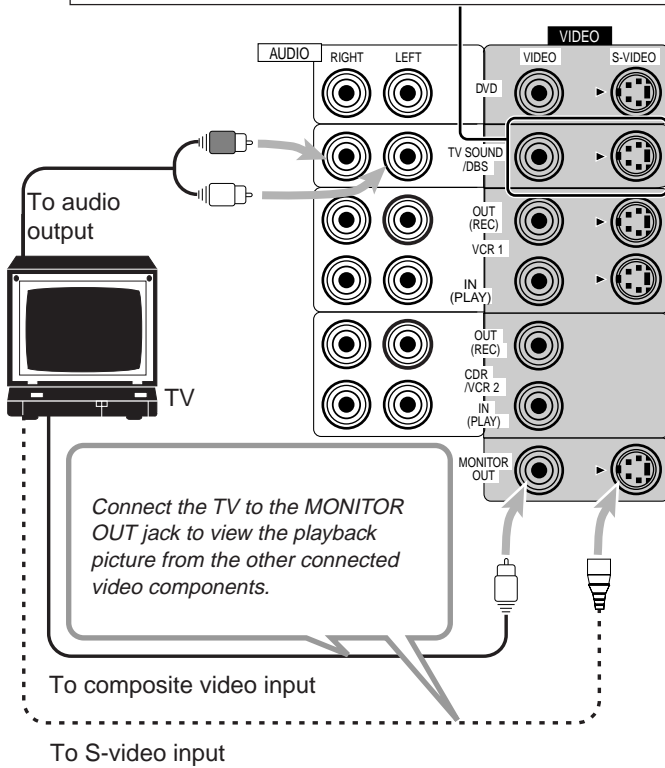

Note:

When connecting the DBS tuner to the TV SOUND/DBS jacks, change the source name, which will be shown on the display when selected as the source, to "DBS." See page 23 for details.

DVD player

- When you connect the DVD player with stereo output jacks:

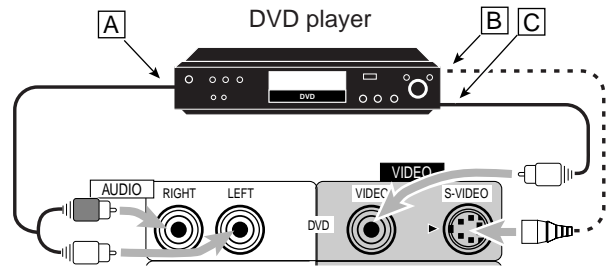

- A To front left/right channel audio output (or to audio mixed output if necessary)
- B To S-video output
- C To composite video output

- When you connect the DVD player with its analog discrete output (5.1 CH reproduction) jacks:

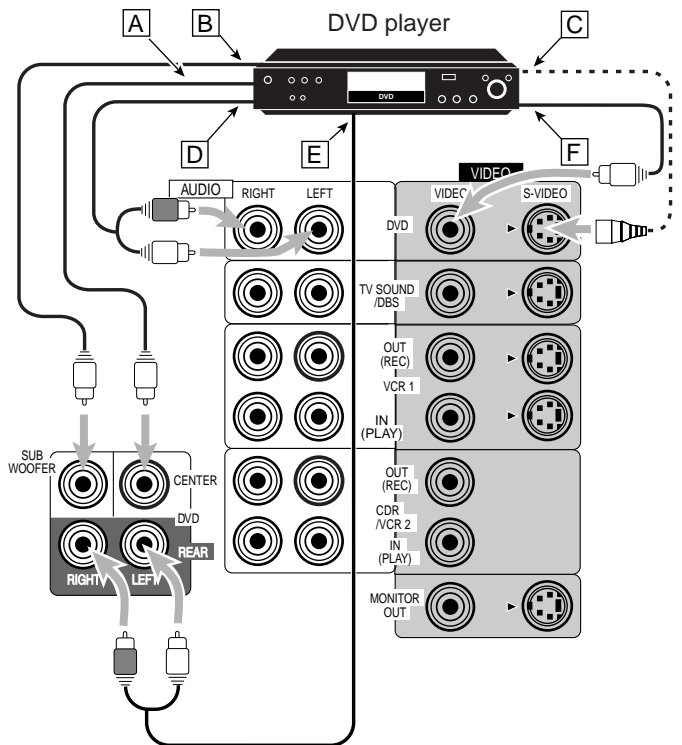

- A To center channel audio output
- B To subwoofer audio output
- C To S-video output
- D To front left/right channel audio output
- E To rear left/right channel audio output
- F To composite video output

Digital connections

This receiver is equipped with four DIGITAL IN terminals — one digital coaxial terminal and three digital optical terminals, and one DIGITAL OUT terminal.

You can connect any digital equipment such as —

- DBS tuner,
- Digital TV broadcast tuner,
- DVD player,
- CD player,
- CD recorder, and
- MD recorder.

IMPORTANT:

- When connecting the DVD player, digital TV broadcast tuner or DBS tuner using the digital terminals, you also need to connect it to the video jack (either composite video terminal or S-video terminal) on the rear. Without connecting it to the video jack, you can view no playback picture.
- After connecting the components using the DIGITAL IN terminals, set the following correctly if necessary.
 - Set the digital input (DIGITAL IN) terminal setting correctly. For details, see “Digital Input (DIGITAL IN) Terminal Setting” on page 26.
 - Select the digital input mode correctly. For details, see “Selecting the Analog or Digital Input Mode” on page 26.

Digital input terminals

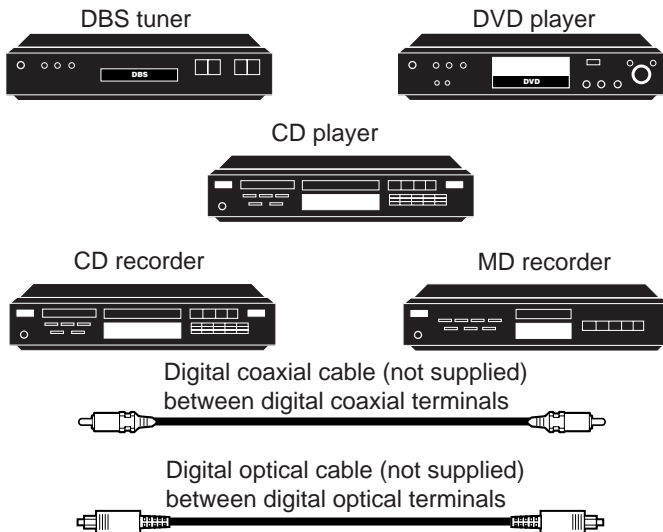

When the component has a digital coaxial output terminal, connect it to the DIGITAL 1 (DVD) terminal, using the digital coaxial cable (not supplied).

When the component has a digital optical output terminal, connect it to the DIGITAL 2 (CD), DIGITAL 3 (TV) or DIGITAL 4 (CDR) terminal, using the digital optical cable (not supplied).

Before connecting a digital optical cable, unplug the protective plug.

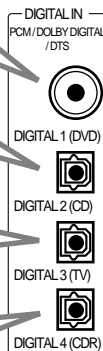
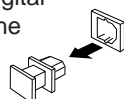

Notes:

- When shipped from the factory, the DIGITAL IN terminals have been set for use with the following components.
 - DIGITAL 1 (coaxial): For DVD player
 - DIGITAL 2 (optical): For CD player
 - DIGITAL 3 (optical): For digital TV broadcast tuner
 - DIGITAL 4 (optical): For CD recorder
- When you want to operate the CD player, CD recorder, or MD recorder using the COMPU LINK remote control system, connect the target component also as described in “Analog connections” (see pages 6 and 7).
- When you want to operate the DVD player using the AV COMPU LINK remote control system, connect the DVD player also as described in “Analog connections” (see page 8).
- To use the digital source components as the sub-room source, you need to connect them using analog connection methods as well.
- When the digital coaxial terminal (DIGITAL 1) and analog pin jacks (analog connection) are both used to connect one source component, you may happen to hear a noise while playing on the source component. If this occurs, use a digital optical terminal (DIGITAL 2/3/4) instead of the digital coaxial terminal (DIGITAL 1).

Digital output terminal



Digital optical cable (not supplied) between digital optical terminals



When the digital recording equipment such as an MD recorder has a digital optical input terminal, connecting it to the DIGITAL OUT terminal enables you to perform digital-to-digital recording.



Note:

The digital signal format output through the DIGITAL OUT terminal is the same as that of the input signal. This means that when the DTS Digital Surround signals are input, the DTS Digital Surround signals are output.

Setting Up the RF Rod Antenna

The RF rod antenna is supplied with this receiver to allow you to use the Multi-room function.

With the RF rod antenna, you can operate the receiver at a distance of up to 50 feet (15 m) using the remote control. However, if the antenna cannot receive signals stably, you cannot operate the receiver correctly.

- The signal-reachable distance may differ depending on the operating conditions and circumstances.

The remote control supplied with this receiver can transmit both RF (Radio Frequency) signal and IR (infrared) signal at the same time to operate the receiver.

The RF rod antenna can receive the RF signals emitted from the remote control. This means that you do not have to aim the remote control at the remote sensor on the receiver when operating the receiver.

- Without the RF rod antenna connected, you can operate the receiver with the remote control, aiming the remote control directly toward the remote sensor on the receiver.

To set up the RF rod antenna

1. Insert the RF rod antenna to the RF REMOTE ANTENNA terminal.

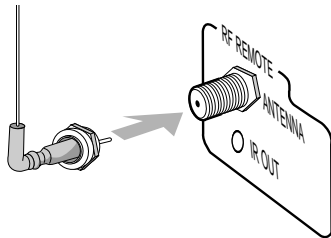

2. Rotate the fixing nut to attach the RF rod antenna firmly.

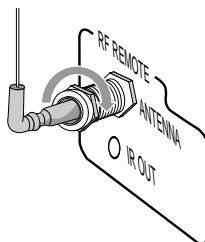

Setting Up the IR Signal Transmitter

The IR signal transmitter can transmit the IR signals.

It allows you to use the AV COMPULINK system, and to operate other manufacturers' video components. Without the IR transmitter connected, you can operate other components with the remote control, aiming the remote control directly toward the remote sensor on the target components. However, the IR signal transmitter reduces the possibility of malfunction.

- The IR signal transmitter may not operate the target components depending on the operating conditions and circumstances — including the aiming angle and direction of the IR signal transmitter toward the remote sensors of the target components. If this occurs, changing its aiming angle and direction toward the remote sensors may solve the problem.

To set up the IR signal transmitter

1. Find the place where you attach the IR signal transmitter.

- Place it where the signal can reach the remote sensor of the target components directly (in the line-of-sight).
- If the cord length of the IR signal transmitter is not long enough, use an extension cord (separately purchased).

2. Attach the double-sided adhesive tape (supplied) to the IR signal transmitter.

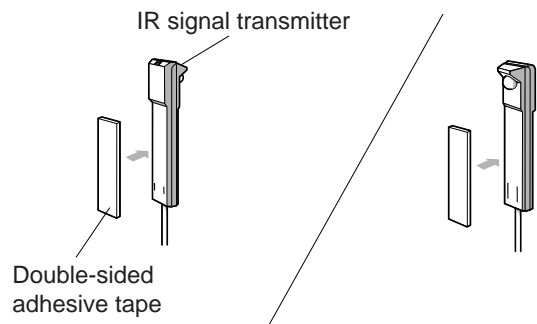

3. Connect the plug of the transmitter to the IR OUT jack of the receiver and place the transmitter.

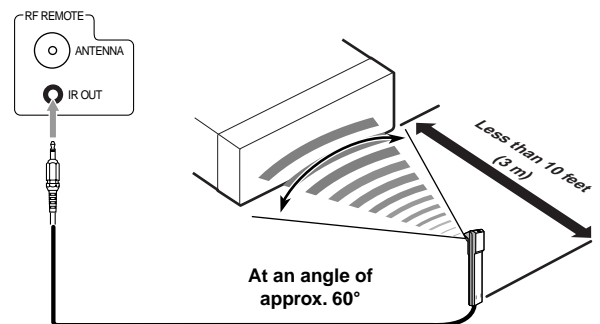

Signal-emitting angle of the transmitter

Horizontally: 60°

Vertically: 60°

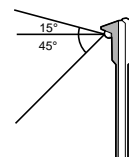
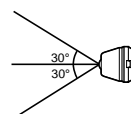

Putting Batteries in the Remote Control

Before using the remote control, put two supplied batteries first.

1. On the back of the remote control, remove the battery cover.

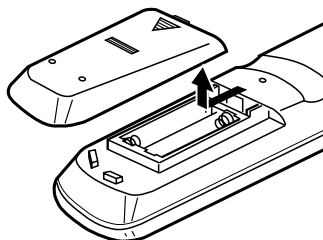

2. Insert batteries. Make sure to match the polarity: (+) to (+).

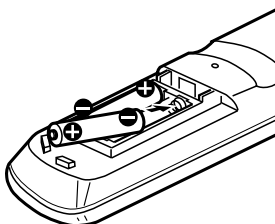

3. Replace the cover.

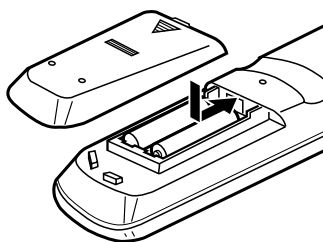

If the remote control cannot transmit signals and operate the receiver correctly, replace the batteries. Use two R6P(SUM3)/AA(15F) type dry-cell batteries.

- When the remote control transmits a signal, the remote operation lamp on the remote control lights up.

Note:

When you can aim the remote control directly at the remote sensor on the receiver, you can operate the receiver at a distance of up to 23 feet (7 m).

CAUTION:

Follow these precautions to avoid leaking or cracking cells:

- Place batteries in the remote control so they match the polarity: (+) to (+).
- Use the correct type of batteries. Batteries that look similar may differ in voltage.
- Always replace both batteries at the same time.
- Do not expose batteries to heat or flame.

Connecting the Power Cord

Before plugging the receiver into an AC outlet, make sure that all connections have been made.

Plug the power cord into an AC outlet.

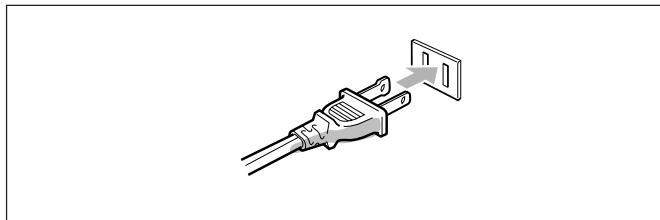

Keep the power cord away from the connecting cables and the antenna. The power cord may cause noise or screen interference. We recommend that you use a coaxial cable to connect the antenna, since it is well-shielded against interference.

Note:

The preset settings such as preset channels and sound adjustment may be erased in a few days in the following cases:

- When you unplug the power cord.
- When a power failure occurs.

CAUTIONS:

- Do not touch the power cord with wet hands.
- Do not pull on the power cord to unplug the cord. When unplugging the cord, always grasp the plug so as not to damage the cord.

Multi-room Operations

Before operating this receiver any further, be familiar with this Multi-room function.

This function enables you to listen to different sources in two different places (we call these two places “main room” and “sub-room”) by using this receiver only.

This section explains only required speaker connections, the concept, and basic operations of the Multi-room function. For more detailed operations, see the respective pages in this manual.

Required Speaker Connections for the Sub-room

Connection A

See also “Connecting the front speakers” on page 5.

Right speaker — MAIN ROOM SPEAKERS — Left speaker

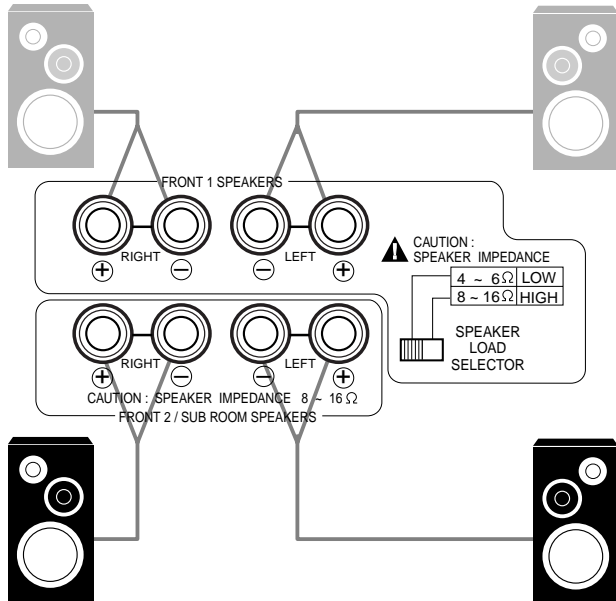

Right speaker — SUB ROOM SPEAKERS — Left speaker

Merits:

- This connection DOES NOT require a power amplifier.

Demerits:

- When the sub-room speakers are activated, this connection DOES NOT allow you to use the DSP mode (see page 32) using the center/rear speakers and the DVD MULTI playback mode (see page 41) for the main room sources.

To use the front speakers connected to the FRONT 2/SUB ROOM SPEAKERS terminals for the sub-room

See “Setting the Front Speakers Either for the Main Room or Sub-room” on page 23, and “Activating the Sub-room Front Speakers” on page 22.

Note:

Using long speaker signal cables will deteriorate the signals, and will result in poor sound quality.

Connection B

Connect the input jacks of another amplifier to the SUB ROOM PRE OUT jacks on the rear panel, using a cable with RCA pin plugs (not supplied).

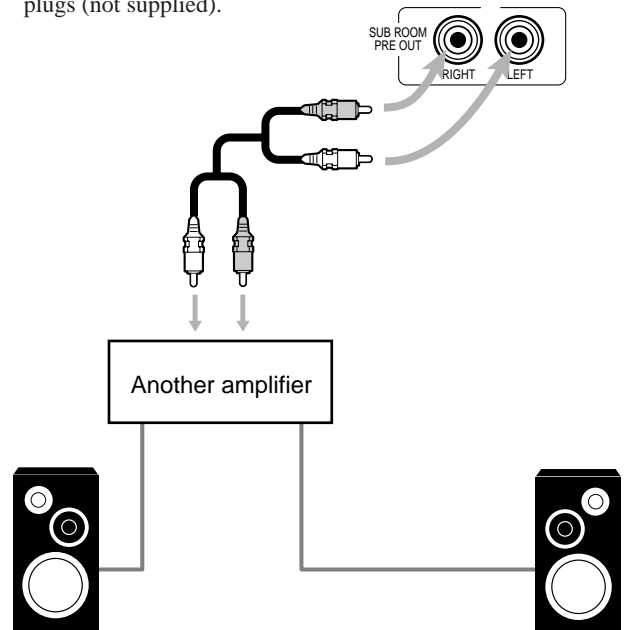

Right speaker — SUB ROOM SPEAKERS — Left speaker

Merits:

- This connection DOES allow you to use the DSP mode (see page 32) using the center/rear speakers and the DVD MULTI playback mode (see page 41) for the main room sources.

Demerits:

- This connection DOES require another amplifier.

To use the front speakers in the sub-room

- No settings are required on this receiver.
- Turn on and operate the other amplifier connected to the SUB ROOM PRE OUT jacks correctly.

Note:

Using long cables will deteriorate the signals, and will result in poor sound quality.

Basic Operating Procedure for Main Room

On the front panel:

1. Press POWER.

The STANDBY lamp on the front panel goes off, and the MAIN ROOM ON/OFF lamp on the front panel lights red.

- For more details, “Turning the Power On and Off (Standby)” on page 15.

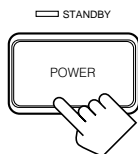

The sound comes out of the speakers in the main room, and the buttons and controls on the front panel work for the main room operations.

2. If no sounds come out of the front speakers, press SPEAKERS 1 (MAIN ROOM) and/or SPEAKERS 2 (SUB ROOM) which you want to use.

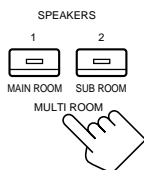

The lamp(s) on the front panel button(s) selected light(s) red.

- For more details, see “Activating the Main Room Front Speakers” on page 17.

3. Select and play a source.

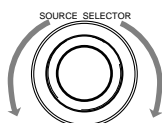

4. Turn MASTER VOLUME to adjust the volume level of the sound from the speakers in the main room.

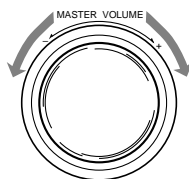

From the remote control:

1. Set the multi-room operation selector to “MAIN ROOM.”

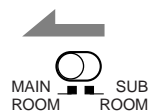

Now the buttons and controls on the remote control work for the main room operations.

2. Press AUDIO POWER ON.

The STANDBY lamp on the front panel goes off, and the MAIN ROOM ON/OFF lamp on the front panel lights red.

- See also “Turning the Power On and Off (Standby)” on page 15.



The sound comes out of the speakers in the main room.

- If no sounds come out of the front speakers, press SPEAKERS 1 (MAIN ROOM) and/or SPEAKERS 2 (SUB ROOM) on the front panel. The SPEAKERS 1 (MAIN ROOM) and/or SPEAKERS 2 (SUB ROOM) lamp(s) on the front panel light(s) red.

For more details, see “Activating the Main Room Front Speakers” on page 17.

3. Select and play a source.

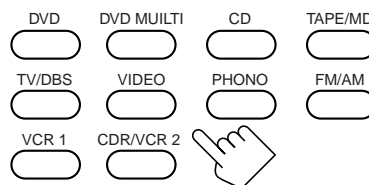

- Before using the remote control, set the remote control mode correctly. (See page 15.)

4. Press VOLUME + / – to adjust the volume level of the sound from the speakers in the main room.



Basic Operating Procedure for Sub-Room

The sources and functions available for the sub-room operations are limited.

For more details on the sub-room operations, see “Sub-room Operations” on pages 20 to 22.

On the front panel:

1. Press POWER.

The STANDBY lamp on the front panel goes off, and the MAIN ROOM ON/OFF lamp on the front panel lights red.

- For more details, “Turning the Power On and Off (Standby) and Selecting the Sub-room Operations” on page 20.

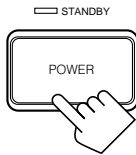

The sound comes out of the speakers in the main room, and the buttons and controls on the front panel work for the main room operations.

2. Press SUB ROOM ON/OFF so that the SUB ROOM ON/OFF lamp on the button lights green.

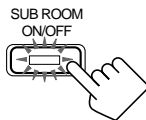

The sound comes out of the front speakers in the sub-room. If no sounds come out of the front speakers, press SUB ROOM (SPEAKERS 2) so that the SUB ROOM speaker (SPEAKERS 2) lamp on the front panel lights green.

- See also “Setting the Front Speakers Either for the Main Room or Sub-room” on page 23, and “Activating the Sub-room Front Speakers” on page 22.

Note:

If the center speaker or rear speakers are used for the DSP mode (see page 32) for the main room operations, the SUB ROOM (SPEAKERS 2) button does not work.

3. Press SUB ROOM CONTROL so that the SUB ROOM CONTROL lamp on the button lights green.

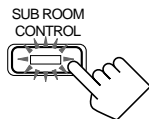

Now the buttons and controls on the front panel work for the sub-room operations.

4. Select and play a source.

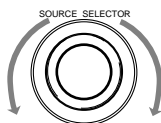

5. Turn MASTER VOLUME to adjust the volume level of the sound from the front speakers in the sub-room.

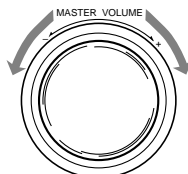

From the remote control:

1. Set the multi-room operation selector to “SUB ROOM.”

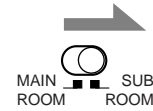

Now the buttons and controls on the remote control work for the sub-room operations.

2. Press AUDIO POWER ON.

The STANDBY lamp on the front panel goes off, and the SUB ROOM ON/OFF lamp on the front panel lights green.

- See also “Turning the Power On and Off (Standby) and Selecting the Sub-room Operations” on page 20.



The sound comes out of the front speakers in the sub-room. If no sounds come out of the front speakers, press SUB ROOM (SPEAKERS 2) on the front panel so that the SUB ROOM speaker (SPEAKERS 2) lamp on the front panel lights green.

- See also “Activating the Sub-room Front Speakers” on page 22.

Note:

If the center speaker or rear speakers are used for the DSP mode (see page 32) for the main room operations, the SUB ROOM (SPEAKERS 2) button does not work.

3. Select and play a source.



- See also “Operating the Playback Source for the Sub-room” on page 22.

4. Press VOLUME + / - to adjust the volume level of the sound from the front speakers in the sub-room.



Main Room Basic Operations

This section explains only the operations commonly used when you play any sound source in the main room. See pages 20 for the sub-room operations.

IMPORTANT:

When using the buttons and controls on the front panel:

Check the following lamps' illumination.

For the main room operations:

- The MAIN ROOM ON/OFF lamp is lit.
- The SUB ROOM CONTROL lamp is not lit.

When using the remote control:

Check to see if the multi-room operation selector and the remote control mode selector are set to the correct positions:

Multi-room operation selector:

To operate this receiver for the main room, set it to "MAIN ROOM."

Remote control mode selector:

To operate this receiver, set it to "AUDIO/TV/VCR."

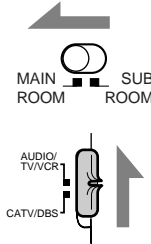

From the remote control:

To turn on the power, press AUDIO POWER POWER ON.

The STANDBY lamp on the front panel goes off, and the MAIN ROOM ON/OFF lamp on the front panel lights red. The name of the current main room source (or station frequency) appears on the display.

The currently selected SPEAKERS 1 (MAIN ROOM) and/or SPEAKERS 2 (SUB ROOM) lamps on the front panel also light red.

- If the SPEAKERS 1 (MAIN ROOM) and/or SPEAKERS 2 (SUB ROOM) lamps on the front panel are not lit, see "Activating the Main Room Front Speakers" on page 17.

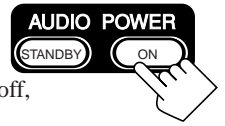

To turn off the power (into standby mode), press AUDIO POWER STANDBY.

The STANDBY lamp lights red.



Notes:

- When you turn off the receiver in the main room, make sure if other people are listening to any source in the sub-room (the SUB ROOM ON/OFF lamp and SUB ROOM speaker (SPEAKERS 2) lamp on the front panel are lit green).
- If you have turned off the receiver with the volume level set at more than level "30," the volume level will be automatically set at level "30" next time you turn on the receiver.
- If "TURN ON MAIN OR SUB ROOM" appears on the display, press MAIN ROOM ON/OFF or SUB ROOM ON/OFF to listen the sound in the main room or in the sub-room; otherwise, the receiver will turn off after about 1 minute.

Turning the Power On and Off (Standby)

On the front panel:

To turn on the power, press POWER.

The STANDBY lamp on the front panel goes off, and the MAIN ROOM ON/OFF lamp on the front panel lights red. The name of the current main room source (or station frequency) appears on the display.

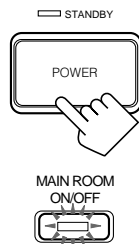

Current source name for main room appears

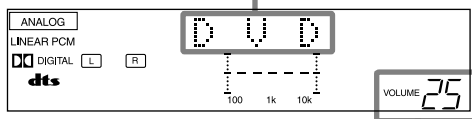

Current volume level for main room is shown here

The currently selected SPEAKERS 1 (MAIN ROOM) and/or SPEAKERS 2 (SUB ROOM) lamps on the front panel also light red.

- If the SPEAKERS 1 (MAIN ROOM) and/or SPEAKERS 2 (SUB ROOM) lamps on the front panel are not lit, see "Activating the Main Room Front Speakers" on page 17.

To turn off the power (into standby mode), press POWER again.

The STANDBY lamp lights red. A small amount of power is consumed in standby mode. To turn the power off completely, unplug the AC power cord.

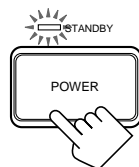

Canceling the Main Room Operations

On the front panel:

To stop the main room operations and sounds from the main room speakers, press MAIN ROOM ON/OFF.

The MAIN ROOM ON/OFF lamp on the button goes off, and the currently selected Front speaker lamp also goes off (no sound will be heard in the main room).

- You cannot use this receiver for the main room operations any more.

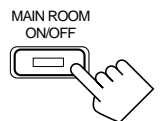

To use this receiver for the main room operations again, press MAIN ROOM ON/OFF again.

The MAIN ROOM ON/OFF lamp on the button lights red, and the currently selected Front speaker lamps also light red.

Now the buttons and controls on the front panel work for the main room operations.

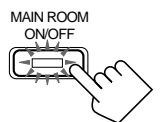

From the remote control:

To stop the main room operations and sounds from the main room speakers, press MAIN ROOM ON/OFF.

The MAIN ROOM ON/OFF lamp on the front panel goes off, and the currently selected Front speaker lamp on the front panel also goes off (no sound will be heard in the main room).

- You cannot use this receiver for the main room operations any more.



To use this receiver for the main room operations again, press MAIN ROOM ON/OFF again. The MAIN ROOM ON/OFF lamp on the front panel lights red, and the currently selected Front speaker lamps on the front panel also light red.

Notes:

- If you have turned off the receiver with the volume level set at more than level “30,” the volume level will be automatically set at level “30” next time you turn on the receiver.
- If “TURN ON MAIN OR SUB ROOM” appears on the display, press MAIN ROOM ON/OFF or SUB ROOM ON/OFF to listen the sound in the main room or in the sub-room; otherwise, the receiver will turn off after about 1 minute.

Selecting the Main Room Source to Play

On the front panel:

Turn SOURCE SELECTOR until the source name you want appears on the display.

- As you turn the selector, the source changes as follows:

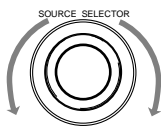

CD ⇄ PHONO ⇄ TAPE (or MD) ⇄ FM ⇄ AM ⇄ DVD ⇄
 DVD MULTI ⇄ TV SOUND (or DBS) ⇄ VCR 1 ⇄
 CDR/VCR 2 ⇄ VIDEO ⇄ (back to the beginning)

The selected source lamp also lights up.

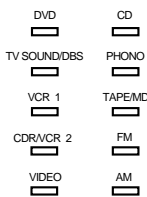

- The DVD lamp lights up both for “DVD” and “DVD MULTI.”

From the remote control:

Press one of the source selecting buttons.

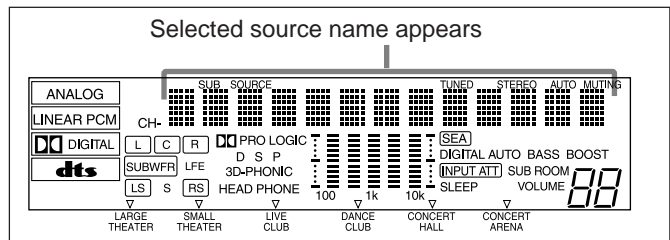
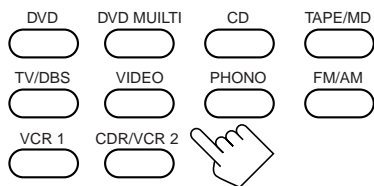

- DVD Select the DVD player.
- DVD MULTI Select the DVD player for viewing the digital video disc using the analog discrete output mode (5.1 CH reproduction) on the DVD player. To enjoy the DVD MULTI playback, see page 41.
- CD * Select the CD player.
- TAPE/MD * Select the cassette deck (or the MD recorder).
- TV/DBS Select TV sounds (or the DBS tuner).
- VIDEO Select video component connected to the VIDEO jacks.
- PHONO * Select the turntable.
- FM/AM * Select an FM or AM broadcast.
 - Each time you press the button, the band alternates between FM and AM.
- VCR 1 Select the video component connected to the VCR 1 jacks.
- CDR/VCR 2 * Select the CD recorder or video component connected to the CDR/VCR 2 jacks.

Notes:

- When connecting an MD recorder (to the TAPE/MD jacks), and a DBS tuner (to the TV SOUND/DBS jacks), change the source name shown on the display. For details, see page 23.
- When you press one of the source selecting buttons on the remote control marked above with an asterisk (*), the receiver automatically turns on.

Signal and speaker indicators on the display

- The signal indicators light up to indicate the incoming channel signals.
 - Only the indicators for the incoming signals light up.
- The frame of the signal indicator (except for “LFE” and “S”) lights up if the corresponding speaker is set to “LARGE” or “SMALL” (for subwoofer, “YES”).
 - The frames of “L” and “R” indicators always light up.

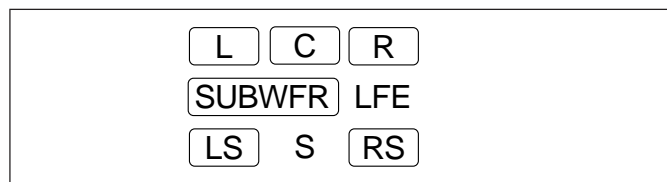

- L:
 - **When digital input is selected:** Lights up when the left channel signal comes in.
 - **When analog input is selected:** Always lights up.
- R:
 - **When digital input is selected:** Lights up when the right channel signal comes in.
 - **When analog input is selected:** Always lights up.
- C: Lights up when the center channel signal comes in.
- LS: Lights up when the left rear channel signal comes in.
- RS: Lights up when the right rear channel signal comes in.
- S: Lights up when the monaural rear channel signal comes in.
- LFE: Lights up when the LFE channel signal comes in.

Notes:

- When “SUBWOOFER” is set to “YES,” SUBWFR lights up.
- When you select “DVD MULTI,” all the signal indicators except “S” light up.

Selecting different sources for picture and sound

You can watch picture from a video component while listening to sound from another component.

On the front panel:

1. Press **SOUND SELECT (INPUT ATT.)** briefly while viewing the picture from a video component such as the VCR or DVD player, etc.

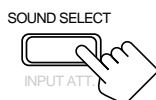

“SOUND SELECT” appears on the display.

2. Turn **SOURCE SELECTOR** to select the sound (except the TV sound), while the indication of the above step is still on the display.

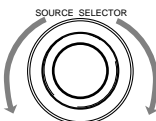

From the remote control:

Press one of the audio source selecting buttons (CD, TAPE/MD, PHONO, FM/AM, TV/DBS*), while viewing the picture from a video component such as the VCR or DVD player, etc.

Notes:

- Once you have selected a video source, pictures of the selected source are sent to the TV until you select another video source.
- * The TV/DBS button only works for selecting “DBS” as the source but not for selecting “TV SOUND.” When you use the DBS tuner, change the source name correctly (see page 23).

Adjusting the Main Room Volume

On the front panel:

To increase the volume, turn MASTER VOLUME clockwise.

To decrease the volume, turn it counterclockwise.

- When you turn MASTER VOLUME rapidly, the volume level also changes rapidly.
- When you turn MASTER VOLUME slowly, the volume level also changes slowly.

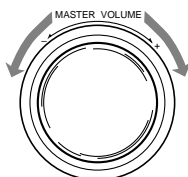

From the remote control:

To increase the volume, press VOLUME +.

To decrease the volume, press VOLUME -.



CAUTIONS:

- Always set the volume to the minimum before starting any source. If the volume is set at its high level, the sudden blast of sound energy can permanently damage your hearing and/or ruin your speakers.
- Be careful not to turn up the volume so high when controlling the receiver without listening to the playback sound. For example, when adjusting the volume level in the sub-room from the main room.

Note:

The volume level can be adjusted within the range of “0” (minimum) to “90” (maximum).

Activating the Main Room Front Speakers

When shipped from the factory, both pairs of the front speakers have been set to be used in the main room.

- To use the front speakers connected to the FRONT 2/SUB ROOM SPEAKERS terminals for the sub-room, see “Setting the Front Speakers Either for the Main Room or Sub-room” on page 23, and “Activating the Sub-room Front Speakers” on page 22.

On the front panel ONLY:

Press **SPEAKERS 1 (MAIN ROOM)** and/or **SPEAKERS 2 (SUB ROOM)** to select the speakers to use in the main room.

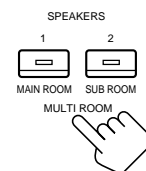

- Each time you press the button, the lamp on the respective button turns on and off. When the lamp on either button lights red, the respective speakers are activated.

IMPORTANT:

You can activate two pairs of the front speakers in the main room at the same time only when the SPEAKER LOAD SELECTOR on the rear panel is set to “HIGH” and when no signals are sent to the center and rear speakers. Otherwise, activating one pair of the speakers deactivates the other.

Note:

If you use any of the DSP modes other than the 3D-PHONIC modes with both front speakers activated in the main room, the speakers connected to the FRONT 2/SUB ROOM SPEAKERS terminals are deactivated.

Listening only with headphones

You can listen with the headphones without deactivating both pairs of speakers for the main room; however, if you want to use the HEADPHONE mode (see below), you must turn off both pairs of speakers.

1. Connect a pair of headphones to the PHONES jack on the front panel.
2. Press **SPEAKERS 1 (MAIN ROOM)** and/or **SPEAKERS 2 (SUB ROOM)** so that no lamps on the buttons are lit red. This cancels the surround mode or DSP mode currently selected, and activates the HEADPHONE mode (see below).
 - The HEAD PHONE indicator lights up on the display.

HEADPHONE mode:

With this mode selected, the bass sounds will not be lost regardless of the speaker setting. So you will not miss them even if you listen to a source using the headphones.

Notes:

- While in the HEADPHONE mode, you cannot use any other DSP modes (see page 32.)
- Activating the speakers cancels the HEADPHONE mode and turns on the DSP mode previously selected.

CAUTION:

Be sure to turn down the volume before connecting or putting on headphones, as high volume can damage both the headphones and your hearing.

Muting the Main Room Sound

From the remote control ONLY:

Press **MUTING** to mute the sound through all speakers in the main room and headphones connected.



“MUTING” appears on the display and the volume turns off (the volume level indicator goes off).

To restore the sound, press **MUTING** again so that “OFF” appears on the display.

- Turning **MASTER VOLUME** on the front panel or pressing **VOLUME +/-** on the remote control also restores the sound.

Reinforcing the Bass

Human ears are not sensitive to bass at low volume. To compensate for this, the bass boost function automatically boost the bass level as you lower the volume.

On the front panel ONLY:

Press **BASS BOOST (SOURCE NAME)** briefly to select the bass boost function.



- Each time you press the button, the bass boost function turns on (“BASSBOOST ON”) and off (“BASSBOOST OFF”).
 - Select “BASSBOOST ON” to activate the bass boost function. The **BASS BOOST** indicator lights up on the display.
 - Select “BASSBOOST OFF” to cancel it. The indicator goes off.

Note:

This function affects the front speaker sounds in the main room only.

Attenuating the Input Signal

When the input level of the playing source is too high, the sounds will be distorted. If this happens, you need to attenuate the input signal level to prevent the sound distortion.

On the front panel ONLY:

Press and hold **INPUT ATT. (SOUND SELECT)** so that the **INPUT ATT.** indicator lights up on the display.

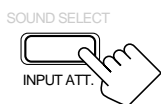

- Each time you press and hold the button, the Input Attenuator mode turns on (“INPUT ATT ON”) or off (“INPUT NORMAL”).

Notes:

- This effect is applied to only the main room sources connected using the analog terminals (except “DVD MULTI”).
- This function takes effect when the DSP mode is in use.

Adjusting the Subwoofer Output Level

You can adjust the subwoofer output level if you have selected “YES” for the “SUBWOOFER” (see page 23). Once it has been adjusted, the receiver memorizes the adjustment.

Before you start, remember...

- There is a time limit in doing the following steps. If the setting is canceled before you finish, start from step 1 again.
- When the front speakers are all deactivated, the subwoofer level cannot be adjusted.

On the front panel:

1. Press **BALANCE/SURROUND ADJUST** repeatedly until “SUBWFR LEVEL” appears on the display.



The display changes to show the current setting.

2. Turn **MULTI JOG** to adjust the subwoofer output level (–10 dB to +10 dB).

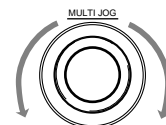

From the remote control:

1. Press **SOUND**.
The 10 keys are activated for sound adjustments.
2. Press **SUBWOOFER +/-** to adjust the subwoofer output level (–10 dB to +10 dB).

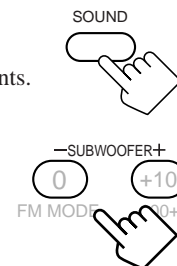

Note:

This function is applied only to the main room sources.

Adjusting the Front Speaker Output Balance

If the sounds you hear from the front right and left speakers are unequal, you can adjust the speaker output balance in the main room.

Before you start, remember...

- There is a time limit in doing the following steps. If the setting is canceled before you finish, start from step 1 again.

On the front panel ONLY:

1. Press **BALANCE/SURROUND ADJUST** repeatedly until “L/R BALANCE” appears on the display.

The display changes to show the current setting.

BALANCE/SURROUND
ADJUST

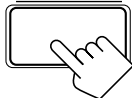

2. Turn **MULTI JOG** to adjust the balance.

- Turning it clockwise decreases the left channel output.
- Turning it counterclockwise decreases the right channel output.

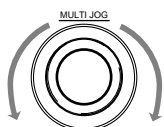

Note:

This function is applied only to the main room sources.

Using the Sleep Timer

Using the Sleep Timer, you can fall asleep to music and know the receiver (or the main room source playback) will turn off by itself rather than play all night.

From the remote control ONLY:

Press **SLEEP** repeatedly.

The SLEEP indicator lights up on the display, and the shut-off time changes as follows (in minutes):

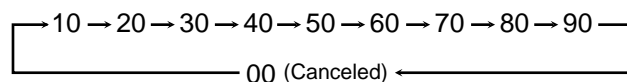

When the shut-off time comes

The receiver turns off (into standby mode) automatically.

- If the sub-room source is still played (the SUB ROOM ON/OFF lamp on the front panel is lit) when the shut-off time comes, the receiver will not turn off, but only the main room sound will shut off.

To check or change the time remaining until the shut-off time

Press **SLEEP** once.

The remaining time until the shut-off time appears in minutes.

- To change the shut-off time, press **SLEEP** repeatedly.

To cancel the Sleep Timer

Press **SLEEP** repeatedly until “SLEEP 00min.” appears on the display. (The SLEEP indicator goes off.)

- Turning off the power also cancels the Sleep Timer.

Changing the Display Brightness

You can dim the display.

On the front panel ONLY:

Press **DIMMER**.

- Each time you press the button, the display dims and brightens alternately.

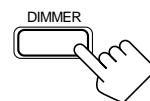

Note:

Even though you have made the display dimmer, it brightens for a while when you operate the receiver.

Recording a Source

For analog-to-analog recording

You can record any analog source through the receiver to —

- the cassette deck (or MD recorder) connected to the TAPE/MD jacks,
- the VCR connected to the VCR 1 jacks, and
- the CD recorder (or VCR) connected to the CDR/VCR2 jacks — at the same time.

For digital-to-digital recording

You can record the currently selected digital input through the receiver to a digital recording device connected to the DIGITAL OUT terminal.

- Digital-to-digital recording is only possible when the digital signal format of the playback source is linear PCM. For recording the playback source of other digital signal formats, use analog-to-analog recording method.

Notes:

- Analog-to-digital and digital-to-analog recordings are not possible.
- The output volume level, bass boost (see page 18), SEA modes (see page 31), and DSP modes (see page 32) cannot affect the recording.
- The test tone signal (see pages 35 and 37) does not come out through the DIGITAL OUT terminal.

IMPORTANT:

- While recording, do not turn off the receiver or main room source; otherwise, recording will stop.
- If the same source is selected both for the main room and the sub-room, operating the sub-room source will affect the recording.

Sub-Room Operations



This section explains only the operations used when you play any sound source in the sub-room. See pages 15 for the main room operations.

IMPORTANT:

When using the buttons and controls on the front panel:

Check the following lamps' illumination.

For the sub-room operations:

- The SUB ROOM ON/OFF lamp is lit.
- The SUB ROOM CONTROL lamp is lit.

When using the remote control:

Check to see if the multi-room operation selector and the remote control mode selector are set to the correct positions:

Multi-room operation selector:

To operate this receiver for the sub-room, set it to "SUB ROOM."

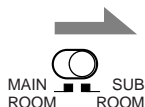

Remote control mode selector:

To operate this receiver, set it to "AUDIO/TV/VCR."

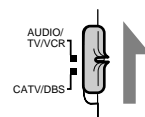

3. Press SUB ROOM CONTROL.

The SUB ROOM CONTROL lamp on the button lights green.

The name of the current source (or station frequency) for the sub-room appears on the display.

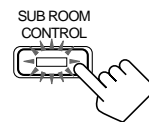

Current source name for sub-room appears

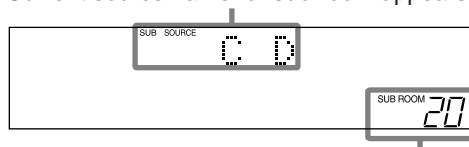

Current volume level for sub-room is shown here

Now the buttons and controls on the front panel work for the sub-room operations.

- Each time you press the button, the lamp on the button turns on and off.

Turning the Power On and Off (Standby) and Selecting the Sub-room Operations

On the front panel:

1. Press POWER.

The STANDBY lamp on the front panel goes off, and the MAIN ROOM ON/OFF lamp on the front panel lights red. The name of the current main room source (or station frequency) appears on the display.

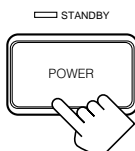

Current source name for main room appears

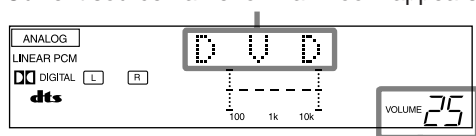

Current volume level for main room is shown here

The currently selected SPEAKERS 1 (MAIN ROOM) and/or SPEAKERS 2 (SUB ROOM) lamps on the front panel also light red.

2. Press SUB ROOM ON/OFF.

The SUB ROOM ON/OFF lamp on the button lights green (and the SUB ROOM speaker (SPEAKERS 2) lamp on the front panel also lights green if it has been activated).

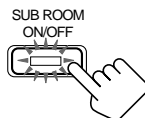

- If the SUB ROOM speaker (SPEAKERS 2) lamp on the front panel is not lit, see also "Setting the Front Speakers Either for the Main Room or Sub-room" on page 23, and "Activating the Sub-room Front Speakers" on page 22.

To turn off the power (into standby mode), press POWER again.

The STANDBY lamp lights red. A small amount of power is consumed in standby mode. To turn the power off completely, unplug the AC power cord.

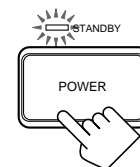

From the remote control ONLY:

1. Set the multi-room operation selector to "SUB ROOM."

Now the buttons on the remote control work for the sub-room operations.

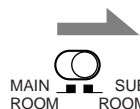

2. Press AUDIO POWER ON.

The STANDBY lamp on the front panel goes off, and the SUB ROOM ON/OFF lamp on the front panel lights green (and the SUB ROOM speaker (SPEAKERS 2) lamp on the front panel also lights green if it has been activated).

- If the SUB ROOM speaker (SPEAKERS 2) lamp on the front panel is not lit, see "Activating the Sub-room Front Speakers" on page 22.

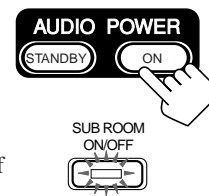

To turn off the power (into standby mode), press AUDIO POWER STANDBY.

The STANDBY lamp lights red, and the SUB ROOM ON/OFF lamp on the front panel goes off.



Note:

If you have turned off the receiver with the volume level set at more than level "30," the volume level will be automatically set at level "30" next time you turn on the receiver.

Canceling the Sub-room Operations

On the front panel:

To stop the sub-room operations and sounds from the sub-room speakers, press SUB ROOM ON/OFF.

The SUB ROOM ON/OFF lamp on the button goes off, and the SUB ROOM speaker (SPEAKERS 2) lamp and SUB ROOM CONTROL lamp on the front panel also go off (no sound will be heard in the sub-room).

- You cannot use this receiver for the sub-room operations any more.

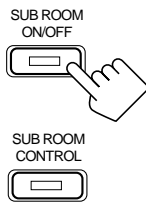

To use this receiver for the sub-room operations again

1. Press SUB ROOM ON/OFF.

The SUB ROOM ON/OFF lamp on the button lights green, and the SUB ROOM speaker (SPEAKERS 2) lamp on the front panel also lights green if it has been activated.

2. Press SUB ROOM CONTROL.

The SUB ROOM CONTROL lamp on the button lights green.

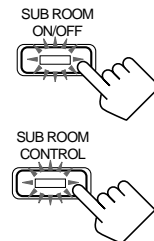

From the remote control:

To stop the sub-room operations and sounds from the sub-room speakers, press SUB ROOM ON/OFF.

The SUB ROOM ON/OFF lamp on the front panel goes off, and the SUB ROOM speaker (SPEAKERS 2) lamp and SUB ROOM CONTROL lamp on the front panel also go off (no sound will be heard in the sub-room).

- You cannot use this receiver for the sub-room operations any more.



To use this receiver for the sub-room operations again, press SUB ROOM ON/OFF again.

The SUB ROOM ON/OFF lamp on the front panel lights green, and the SUB ROOM speaker (SPEAKERS 2) lamp on the front panel also lights green if it has been activated.

Notes:

- If you have turned off the sub-room sound with the volume level set at more than level "30, the volume level will be automatically set at level "30" next time you turn on the sub-room sound.
- If "TURN ON MAIN OR SUB ROOM" appears on the display, press MAIN ROOM ON/OFF or SUB ROOM ON/OFF to listen to the sound in the main room or in the sub-room; otherwise, the receiver will turn off after about 1 minute.

Selecting the Sub-room Source to Play

On the front panel:

Turn SOURCE SELECTOR until the source name you want appears on the display.

- As you turn the selector, the source changes as follows:

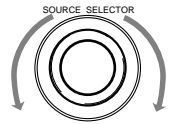

CD ⇄ PHONO ⇄ TAPE (or MD) ⇄ FM ⇄ AM ⇄ DVD ⇄ DBS ⇄ VCR 1 ⇄ CDR/VCR 2 ⇄ VIDEO ⇄ (back to the beginning)

Selected source name for sub-room appears

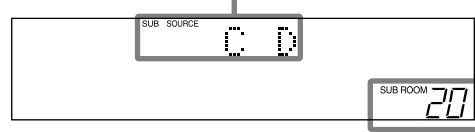

Current volume level for sub-room is shown here

From the remote control:

Press one of the source selecting buttons.

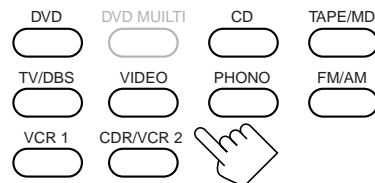

- DVD Select the DVD player.
- CD * Select the CD player.
- TAPE/MD * Select the cassette deck (or the MD recorder).
- TV/DBS Select the DBS tuner.
 - Does not work for selecting TV sound.
- VIDEO Select video component connected to the VIDEO jacks.
- PHONO * Select the turntable.
- FM/AM * Select an FM or AM broadcast.
 - Each time you press the button, the band alternates between FM and AM.
- VCR 1 Select the video component connected to the VCR 1 jacks.
- CDR/VCR 2 * Select the CD recorder or video component connected to the CDR/VCR 2 jacks.

Notes:

- When you press one of the source selecting buttons on the remote control marked above with an asterisk (*), the receiver automatically turns on.
- The source lamp does not light for the sub-room source.
- You cannot select the following as the sub-room source:
 - "TV SOUND"
 - "DVD MULTI"
 - Any digital input such as "DVD DIGITAL" or "CD DIGITAL." You can only select the analog input as the sub-room source.
- You can select the video components as the sub-room source; however, you can see no pictures.

Adjusting the Sub-room Volume

On the front panel:

To increase the volume, turn MASTER VOLUME clockwise.

To decrease the volume, turn it counterclockwise.

- When you turn MASTER VOLUME rapidly, the volume level also changes rapidly.
- When you turn MASTER VOLUME slowly, the volume level also changes slowly.

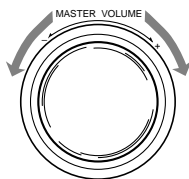

From the remote control:

To increase the volume, press VOLUME +.

To decrease the volume, press VOLUME -.

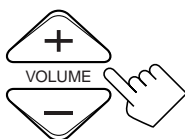

CAUTIONS:

- Always set the volume to the minimum before starting any source. If the volume is set at its high level, the sudden blast of sound energy can permanently damage your hearing and/or ruin your speakers.
- Be careful not to turn up the volume so high when controlling the receiver without listening to the playback sound. For example, when adjusting the volume level in the sub-room from the main room.

Note:

The volume level can be adjusted within the range of "0" (minimum) to "90" (maximum).

Activating the Sub-room Front Speakers

This section is not for the persons who connect the sub-room front speakers to the SUB ROOM PRE OUT jacks using another amplifier (see page 12).

Before you start, remember...

- When shipped from the factory, both pairs of the front speakers have been set to be used in the main room. To use the front speakers connected to the FRONT 2/SUB ROOM SPEAKERS terminals for the sub-room, see "Setting the Front Speakers Either for the Main Room or Sub-room" on page 23.

On the front panel ONLY:

Press SUB ROOM (SPEAKERS 2) to activate the front speakers in the sub-room.

The lamp on the button lights green.

- Each time you press the button, the lamp on the button turns on and off.

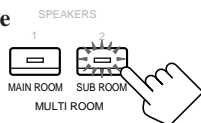

To deactivate the front speakers in the sub-room, press SUB ROOM (SPEAKERS 2) again.

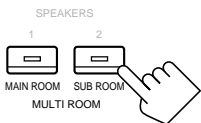

Note:

If the center speaker or rear speakers are used for the DSP mode (see page 32) for the main room operations, the SUB ROOM (SPEAKERS 2) button does not work.

Muting the Sub-room Sound

From the remote control ONLY:

Press MUTING to mute the sound through the front speaker in the sub-room.

The volume level indicator goes off.



To restore the sound, press MUTING again so that the volume level indicator appears on the display.

- Turning MASTER VOLUME on the front panel or pressing VOLUME +/- on the remote control also restores the sound.

Operating the Playback Source for the Sub-room

- When you select "FM" or "AM" as the sub-room source, you can do the following:
 - Tune into any station frequency manually (see page 29).
 - Select a preset station (see page 30).
 - Select FM reception mode (see page 30).
- When you select the other sources as the sub-room source, you can operate them by using the remote control supplied with this receiver. ("TV SOUND," "DVD MULTI" and the digital input cannot be selected as the sub-room source.)
 - If they are one of the JVC products equipped with the COMPU LINK remote control system or the AV COMPU LINK remote control system, see pages 57 to 59.
 - If they are one of the JVC products, but not equipped with the above remote control systems, or if they are the products of the other manufacturers, see pages 60 to 62.

CAUTION:

Be careful not to turn up the volume so high when controlling the receiver without listening to the playback sound. For example, when adjusting the volume level in the sub-room from the main room.

Notes:

- Any sound adjustments such as the SEA or DSP modes cannot be applied to the sub-room source. You can only adjust the volume level.
- The One Touch Operation function (see page 28) cannot be used for the sub-room sources.

Basic Settings

Some of the following settings are required after connecting and positioning your speakers, while others will make operations easier.

The following operations are only possible while the receiver is ready for the main room operations.

IMPORTANT:

When using the buttons and controls on the front panel:

Check the following lamps' illumination.

For the main room operations:

- The MAIN ROOM ON/OFF lamp is lit.
- The SUB ROOM CONTROL lamp is not lit.

When using the remote control:

Check to see if the multi-room operation selector and the remote control mode selector are set to the correct positions:

Multi-room operation selector:

To operate this receiver for the main room, set it to "MAIN ROOM."

Remote control mode selector:

To operate this receiver, set it to "AUDIO/TV/VCR."

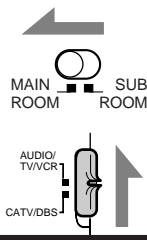

Changing the Source Name

When you have connected an MD recorder to the TAPE/MD jacks or the DBS tuner to the TV SOUND/DBS jacks on the rear panel, change the source name which will be shown on the display when you select the MD recorder or DBS tuner as the source.

On the front panel ONLY:

1. When changing the source name from "TAPE" to "MD":

- Turn SOURCE SELECTOR until "TAPE" appears.

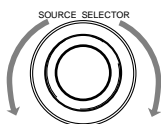

When changing the source name from "TV SOUND" to "DBS":

- Turn SOURCE SELECTOR until "TV SOUND" appears.

2. Press and hold SOURCE NAME (BASS BOOST) until "ASSGN. MD" or "ASSGN. DBS" appears on the display.



To change the source name to "TAPE" or "TV SOUND," repeat the same procedure above — in step 1, select "MD" or "DBS" then press and hold SOURCE NAME (BASS BOOST).

Notes:

- You can only assign the correct source name to "TAPE/MD" and "TV SOUND/DBS," but not to "CDR/VCR 2."
- Without changing the source name, you can still use the connected components. However, there may be some inconvenience.
 - "TAPE" or "TV SOUND" will appear on the display when you select the MD recorder or DBS tuner.
 - You cannot use the digital input (see page 26) for the MD recorder.
 - You cannot use the COMPU LINK remote control system (see page 47) to operate the MD recorder.

Setting the Front Speakers Either for the Main Room or Sub-room

You can use the front speakers connected to the FRONT 2/SUB ROOM SPEAKERS terminals either as the 2nd front speakers in the main room or as the front speakers in the sub-room.

Before you start, remember...

- There is a time limit in doing the following steps. If the setting is canceled before you finish, start from step 1 again.

On the front panel ONLY:

1. Press SETTING repeatedly until "SPEAKER 2" appears on the display.

The display changes to show the current setting.

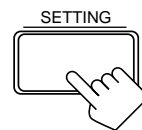

2. Turn MULTI JOG to specify the way you want to use the speakers connected to the FRONT 2/SUB ROOM terminals.

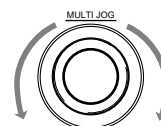

- As you turn it, the display changes to show the following:

MAIN ←→ SUB

MAIN: Select this to use as the 2nd front speakers in the main room.

SUB: Select this to use as the front speakers in the sub-room.

Setting the Subwoofer Information

Register whether or not you have connected a subwoofer.

Before you start, remember...

- There is a time limit in doing the following steps. If the setting is canceled before you finish, start from step 1 again.

On the front panel:

1. Press SETTING repeatedly until "SUBWOOFER" appears on the display.

The display changes to show the current setting.

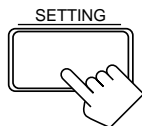

2. Turn MULTI JOG to register whether you have connected a subwoofer or not.

- As you turn it, the subwoofer setting alternates between "YES" and "NO."

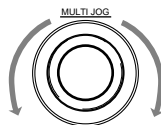

YES: Select this when a subwoofer is used. [SUBWFR] lights up on the display (see page 16).

NO: Select this when no subwoofer is used.

Setting the Speakers for the DSP Modes

To obtain the best possible surround sound of the DSP modes, you have to register the information about the speakers arrangement after all connections are completed.

Before you start, remember...

- There is a time limit in doing the following steps. If the setting is canceled before you finish, start from step 1 again.

Front, Center, and Rear Speaker Setting

Register the sizes of all the connected speakers.

- When you change your speakers, you need to register the information about the speakers again.

On the front panel ONLY:

1. Press **SETTING** repeatedly until “**FRONT SPK**” (Front Speaker), “**CENTER SPK**” (Center Speaker) or “**REAR SPK**” (Rear Speaker) appears on the display.

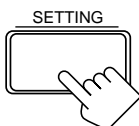

The display changes to show the current setting.

2. Turn **MULTI JOG** to select the appropriate item about the speaker selected in the above step.

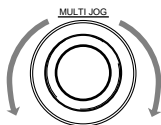

- As you turn it, the display changes to show the following:

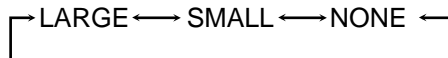

LARGE: Select this when the speaker size is relatively large.

SMALL: Select this when the speaker size is relatively small.

NONE: Select this when you have not connected a speaker. (Not selectable for the front speakers)

3. Repeat steps 1 and 2 to select the appropriate items for the other speakers.

Notes:

- Keep the following comment in mind as reference when adjusting.
 - If the size of the cone speaker unit built in your speaker is greater than 4 3/4 inches (12 cm), select “LARGE,” and if it is smaller than 4 3/4 inches (12 cm), select “SMALL.”
- If you have selected “NO” for the subwoofer setting, you can only select “LARGE” for the front speaker setting.
- If you have selected “SMALL” for the front speaker setting, you cannot select “LARGE” for the center and rear speaker settings.

Center Delay Time Setting

Register the delay time of the sound from the center speaker, comparing to that of the sound from the front speakers.

If the distance from your listening point to the center speaker is equal to that to the front speakers, select 0 msec. As the distance to the center speaker becomes shorter, increase the delay time.

- 1 msec increase (or decrease) in delay time corresponds to 11 13/16 inches (30 cm) decrease (or increase) in distance.
- When shipped from the factory, delay time is set to 0 msec.

On the front panel ONLY:

1. Press **SETTING** repeatedly until “**CENTER DELAY**” appears on the display.

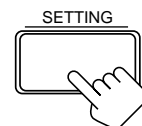

The display changes to show the current setting.

2. Turn **MULTI JOG** to select the delay time of the center speaker output.

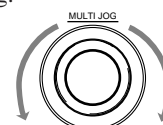

- Turn it clockwise to increase the delay time from 0 msec (“C. DELAY: 0ms”) to 5 msec (“C. DELAY: 5ms”).
- Turn it counterclockwise to decrease the delay time from 5 msec (“C. DELAY: 5ms”) to 0 msec (“C. DELAY: 0ms”).

Notes:

- Center delay time setting is not valid for the DVD MULTI playback mode.
- You cannot adjust the center delay time when you have set “CENTER SPK” to “NONE.”

Rear Delay Time Setting

Register the delay time of the sound from the rear speakers, comparing to that of the sound from the front speakers.

If the distance from your listening point to the rear speakers is equal to that to the front speakers, select 0 msec. As the distance to the rear speakers becomes shorter, increase the delay time.

- 1 msec increase (or decrease) in delay time corresponds to 11 13/16 inches (30 cm) decrease (or increase) in distance.
- Rear delay time for Dolby Digital and DTS Digital Surround is to be set to 5 msec.
- When shipped from the factory, delay time is set to 5 msec.

On the front panel ONLY:

1. Press **SETTING** repeatedly until “**REAR DELAY**” appears on the display.

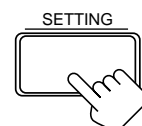

The display changes to show the current setting.

2. Turn MULTI JOG to select the delay time of the rear speaker output.

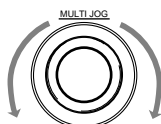

- Turn it clockwise to increase the delay time from 0 msec (“R. DELAY: 0ms”) to 15 msec (“R. DELAY: 15ms”).
- Turn it counterclockwise to decrease the delay time from 15 msec (“R. DELAY: 15ms”) to 0 msec (“R. DELAY: 0ms”).

Notes:

- Rear delay time setting is not valid for the DVD MULTI playback mode.
- You cannot adjust the rear delay time when you have set “REAR SPK” to “NONE.”

Crossover Frequency Setting

Small speakers cannot reproduce the bass sound very well. So, if you have used a small speaker for any of the front, center, and rear channels, this receiver automatically reallocate the bass elements, originally assigned to the channel for which you have connected the small speaker, to another channel (for which you have connected the large speaker).

To use this function properly, you need to set the crossover frequency level according to the size of the small speaker connected.

- If you have selected “LARGE” for all speakers (see page 24), this function is set to “OFF” and cannot be adjusted.

On the front panel ONLY:

1. Press **SETTING** repeatedly until “**CROSSOVER FRQ**” (Crossover Frequency) appears on the display.

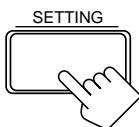

The display changes to show the current setting.

2. Turn **MULTI JOG** to select the crossover frequency level according to the size of the small speaker connected.

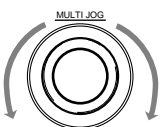

- As you turn it, the display changes to show the following:

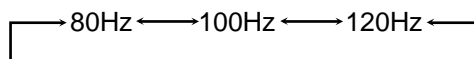

- Use the following comments as reference when adjusting.

80Hz:	Select this when the cone speaker unit built in the speaker is about 4 ³ / ₄ inches (12 cm).
100Hz:	Select this when the cone speaker unit built in the speaker is about 3 ¹⁵ / ₁₆ inches (10 cm).
120Hz:	Select this when the cone speaker unit built in the speaker is about 3 ³ / ₁₆ inches (8 cm).

Note:

Crossover frequency setting is not valid for the DVD MULTI playback mode, 3D-PHONIC mode, and HEADPHONE mode.

Low Frequency Effect Attenuator Setting

If the bass sound is distorted while playing back a source using Dolby Digital or DTS Digital Surround, follow the procedure below.

On the front panel ONLY:

1. Press **SETTING** repeatedly until “**LFE ATT**” (Low Frequency Effect Attenuator) appears on the display.

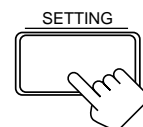

The display changes to show the current setting.

2. Turn **MULTI JOG** to select the low frequency effect attenuator level.

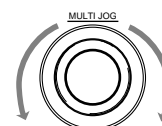

- As you turn it, the display changes to show the following:

0dB ←→ 10dB

0dB: Normally select this.

10dB: Select this when the bass sound is distorted.

Note:

Low frequency effect attenuator setting is not valid for the DVD MULTI playback mode.

Dynamic Range Compression Setting

You can compress the dynamic range (difference between maximum sound and minimum sound) of the reproduced sound. This is useful when enjoying surround sound at night.

- This function takes effect only when playing back a source encoded with Dolby Digital.

On the front panel ONLY:

1. Press **SETTING** repeatedly until “**D. RANGE COMP**” (Dynamic Range Compression) appears on the display.

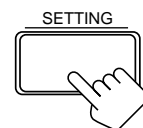

The display changes to show the current setting.

2. Turn **MULTI JOG** to select the appropriate item about the compression level.

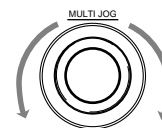

- As you turn it, the display changes to show the following:

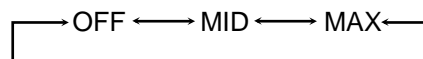

OFF: Select this when you want to enjoy surround with its full dynamic range. (No effect applied)

MID: Select this when you want to reduce the dynamic range a little. (Factory setting)

MAX: Select this when you want to apply the compression effect fully. (Useful at night)

Note:

Dynamic range compression setting is not valid for the DTS Digital Surround and DVD MULTI playback mode.

Digital Input (DIGITAL IN) Terminal Setting

When you use the digital input terminals, you have to register what components are connected to which terminals (DIGITAL IN 1/2/3/4).

Before you start, remember...

- There is a time limit in doing the following steps. If the setting is canceled before you finish, start from step 1 again.

On the front panel ONLY:

To set the DIGITAL 1 terminal

1. Press **SETTING** repeatedly until “COAX. DIG. IN” appears on the display.

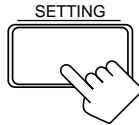

The display changes to show the current setting.

2. Turn **MULTI JOG** to select the appropriate digital terminal setting.

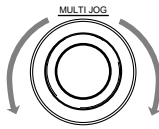

- As you turn it, the display changes to show the following:

1 DVD ⇄ 1 MD ⇄ 1 CDR ⇄ 1 TV (or 1 DBS*) ⇄
1 CD ⇄ (back to the beginning)

- * If you have changed the source name from “TV SOUND” to “DBS,” “DBS” appears.

To set the DIGITAL 2/3/4 terminal

1. Press **SETTING** repeatedly until “OPT. DIG. IN” appears on the display.

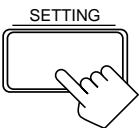

The display changes to show the current setting.

DIGITAL 3 terminal setting

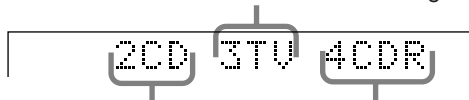

DIGITAL 2 terminal setting DIGITAL 4 terminal setting

2. Turn **MULTI JOG** to select the appropriate digital terminal settings.

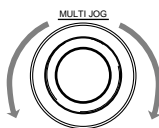

- As you turn it, the display changes to show the following:

When the DIGITAL 1 is set to “DVD”

2 CD 3 TV (or 2 DBS*) 4 CDR ⇄
2 CD 3 TV (or 2 DBS*) 4 MD ⇄
2 CD 3 MD 4 CDR ⇄
2 MD 3 TV (or 2 DBS*) 4 CDR ⇄
(back to the beginning)

When the DIGITAL 1 is set to “MD”

2 CD 3 TV (or 2 DBS*) 4 CDR ⇄
2 CD 3 TV (or 2 DBS*) 4 DVD ⇄
2 CD 3 DVD 4 CDR ⇄
2 DVD 3 TV (or 2 DBS*) 4 CDR ⇄
(back to the beginning)

When the DIGITAL 1 is set to “CDR”

2 CD 3 TV (or 4 DBS*) 4 DVD ⇄
2 CD 3 TV (or 4 DBS*) 4 MD ⇄
2 CD 3 MD 4 DVD ⇄
2 MD 3 TV (or 4 DBS*) 4 DVD ⇄
(back to the beginning)

When the DIGITAL 1 is set to “TV” or “DBS”

2 CD 3 DVD 4 CDR ⇄ 2 CD 3 DVD 4 MD ⇄
2 CD 3 MD 4 CDR ⇄ 2 MD 3 DVD 4 CDR ⇄
(back to the beginning)

When the DIGITAL 1 is set to “CD”

2 DVD 3 TV (or 3 DBS*) 4 CDR ⇄
2 DVD 3 TV (or 3 DBS*) 4 MD ⇄
2 DVD 3 MD 4 CDR ⇄
2 MD 3 TV (or 3 DBS*) 4 CDR ⇄
(back to the beginning)

- * If you have changed the source name from “TV SOUND” to “DBS,” “DBS” appears.

Note:

When shipped from the factory, the DIGITAL IN terminals can be used as the digital input for the following components.

- DIGITAL 1 (coaxial): For DVD player
- DIGITAL 2 (optical): For CD player
- DIGITAL 3 (optical): For digital TV broadcast tuner
- DIGITAL 4 (optical): For CD recorder

Selecting the Analog or Digital Input Mode

When you have connected digital source components using the digital terminals (see page 9), you need to change the input mode for these components to the appropriate digital input mode correctly — AUTO/PCM, DOLBY DIGITAL, or DTS.

Before you start, remember...

- The digital input (DIGITAL IN) terminal setting should be correctly done for the sources you want to select the digital input mode for. Without setting this digital input terminal correctly, you cannot change the input mode from analog input to digital input even if you follow the procedure below.
- The digital input can be used for the main room sources. The analog input is always selected as the sub-room source without respect to this setting.

On the front panel:

1. Turn **SOURCE SELECTOR** until the source (CD, MD, TV SOUND, DBS, DVD, or CDR/VCR2)* for which you want to change the input mode appears on the display.

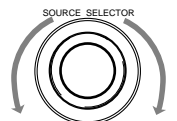

Note:

- * Among the sources listed above, you can select the digital input only for the sources which you have selected the digital input terminals for. (See “Digital Input (DIGITAL IN) Terminal Setting.”)

2. Press INPUT ANALOG/DIGITAL repeatedly until the digital input mode you want appears on the display.



- Each time you press the button, the input mode changes as follows:

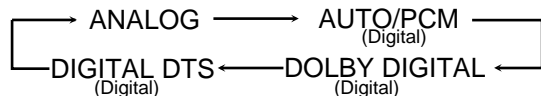

Normally select "AUTO/PCM," so the receiver automatically detects the incoming digital signal format. (The DIGITAL AUTO indicator lights up on the display.)

When the receiver can recognize the digital signal format coming into the receiver, the frame of the digital signal indicator for the detected signal lights up automatically.

With "DOLBY DIGITAL" or "DIGITAL DTS" selected, the frame of the digital signal indicator flashes when signals of a different digital signal format come in. In this case, select the same digital input mode with the incoming digital signal.

To change the input mode back to analog input, select "ANALOG."

From the remote control:

1. Press the source selecting button (CD, TAPE/MD, TV/DBS, DVD, or CDR/VCR2)* for which you want to change the input mode.



Note:

* Among the sources listed above, you can select the digital input only for the sources which you have selected the digital input terminals for. (See "Digital Input (DIGITAL IN) Terminal Setting.")

2. Press ANALOG/DIGITAL to change the input mode.

- Each time you press the button, the input mode changes as follows:

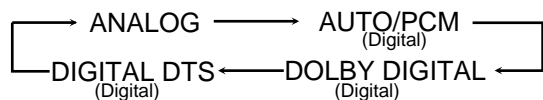

Notes:

- Noise may come out of the speakers while searching or skipping a multichannel source encoded with Dolby Digital or DTS Digital Surround. If this happens, select "DOLBY DIGITAL" or "DIGITAL DTS" for digital input mode.
- When you change the source or turn on or off the power, the digital input mode will be automatically reset to "AUTO/PCM."

Showing the Text Information on the Display

When you have connected an MD recorder or CD player equipped with TEXT COMPU LINK remote control system (see page 49), you can show the text information, such as disc title or track title, on the display of this receiver. To show it on the display, follow the procedure below.

Before you start, remember...

- There is a time limit in doing the following steps. If the setting is canceled before you finish, start from step 1 again.

On the front panel only:

1. Press SETTING repeatedly until "FL DISPLAY" appears on the display.

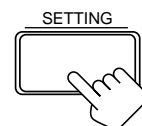

The display changes to show the current setting.

2. Turn MULTI JOG to select either the source name or the text information to be shown on the display.

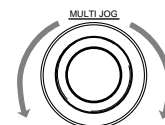

- As you turn it, the display changes to show the following:

NORMAL ←→ TEXT

NORMAL: Source name appears during play.

TEXT: Text information appears during play.

Note:

Though you have selected "TEXT," the source name such as "CD" or "MD" appears if a playing disc has no text information.

Receiving Radio Broadcasts

You can browse through all the stations or use the preset function to go immediately to a particular station.



Indicates the functions YOU CAN ALSO USE when the receiver is ready for the sub-room operations.

IMPORTANT:

When using the buttons and controls on the front panel:

Check the following lamps' illumination.

For the main room operations:

- The MAIN ROOM ON/OFF lamp is lit.
- The SUB ROOM CONTROL lamp is not lit.

For the sub-room operations:

- The SUB ROOM ON/OFF lamp is lit.
- The SUB ROOM CONTROL lamp is lit.

When using the remote control:

Check to see if the multi-room operation selector and the remote control mode selector are set to the correct positions:

Multi-room operation selector:

To operate this receiver for the main room, set it to "MAIN ROOM."

To operate this receiver for the sub-room, set it to "SUB ROOM."

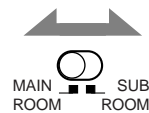

Remote control mode selector:

To operate this receiver, set it to "AUDIO/TV/VCR."

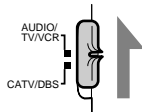

Tuning in Stations Manually



On the front panel:

1. Turn SOURCE SELECTOR to select the band (FM or AM).

The last received station of the selected band is tuned in.

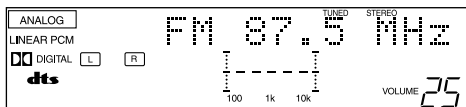

2. Press FM/AM TUNING.

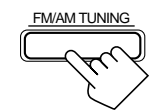

3. Turn MULTI JOG until you find the frequency you want.

- Turning it clockwise increases the frequency.
- Turning it counterclockwise decreases the frequency.
- When you turn MULTI JOG quickly, the frequency keeps changing until a station is tuned in.

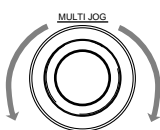

From the remote control:

1. Press FM/AM to select the band.

- Each time you press the button, the band alternates between FM and AM.

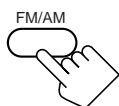

2. Press TUNING UP or TUNING DOWN repeatedly until you find the frequency you want.

- When you hold the button (and release it), the frequency keeps changing until a station is tuned in.

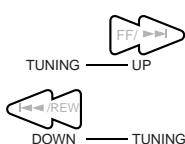

Notes:

- When a station of sufficient signal strength is tuned in, the TUNED indicator lights up on the display. When an FM stereo program is received, the STEREO indicator also lights up.
- You can only select the same station of the same band (FM or AM) both for the main room and sub-room operations. If you change the station for the sub-room, it also changes for the main room (and vice versa). This also means that if you change the station for the sub-room while recording a broadcasting program in the main room, recording in the main room will be interrupted.

Using Preset Tuning

Once a station is assigned to a channel number, the station can be quickly tuned. You can preset up to 30 FM and 15 AM stations.

To store the preset stations

Before you start, remember...

- There is a time limit in doing the following steps. If the setting is canceled before you finish, start from step 1 again.

On the front panel ONLY:

1. Tune in the station you want to preset (see "Tuning in Stations Manually").

- If you want to store the FM reception mode for this station, select the FM reception mode you want. See "Selecting the FM Reception Mode" on page 30.

2. Press TUNER/SEA MEMORY.

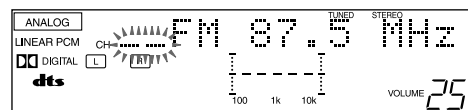

"CH-" appears and the channel number position starts flashing on the display for about 10 seconds.

3. Turn MULTI JOG to select a channel number while the channel number position is flashing.

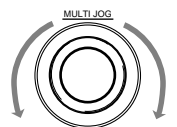

Note:

You can use the 10 keys on the remote control to select the preset number. When using the 10 keys, be sure that they are activated for the tuner, not for the CD and others. (See page 57.)

4. Press TUNER/SEA MEMORY again while the selected channel number is flashing.

The selected channel number stops flashing. The station is assigned to the selected channel number.

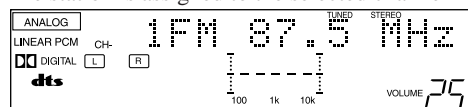

5. Repeat steps 1 to 4 until you store all the stations you want.

To erase a stored preset station

Storing a new station on a used number erases the previously stored one.

To tune in a preset station



On the front panel:

1. Turn SOURCE SELECTOR to select the band (FM or AM).

The last received station of the selected band is tuned in.

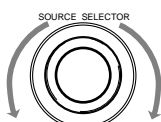

2. Press TUNER PRESET.

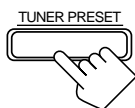

3. Turn MULTI JOG until you find the channel you want.

- Turning it clockwise increases the channel numbers.
- Turning it counterclockwise decreases the channel numbers.

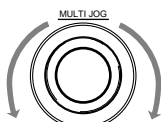

From the remote control:

1. Press FM/AM.

- Each time you press the button, the band alternates between FM and AM.

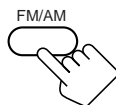

2. Press the 10 keys to select a preset channel number.

- For channel number 5, press 5.
- For channel number 15, press +10 then 5.
- For channel number 20, press +10 then 10.
- For channel number 30, press +10, +10, then 10.

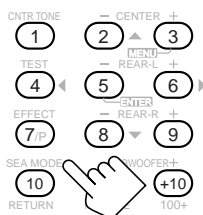

Notes:

- You can only select the same station of the same band (FM or AM) both for the main room and sub-room operations. If you change the station for the sub-room, it also changes for the main room (and vice versa). This also means that if you change the station for the sub-room while recording a broadcasting program in the main room, recording in the main room will be interrupted.
- When you use the 10 keys on the remote control, be sure that they are activated for the tuner, not for the CD and others. (See page 57.)

Selecting the FM Reception Mode



When an FM stereo broadcast is hard to receive or noisy

You can change the FM reception mode while receiving an FM broadcast.

- You can store the FM reception mode for each preset station.

Press FM MODE on the front panel or on the remote control.

- Each time you press the button, the FM reception mode alternates between “AUTO MUTING” and “MONO.”

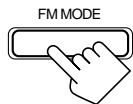

On the front panel



On the remote control

AUTO MUTING: When a program is broadcasted in stereo, you will hear stereo sound; when in monaural, you will hear monaural sounds. This mode is also useful to suppress static noise between stations. The AUTO MUTING indicator lights up on the display.

MONO: Reception will be improved although you will lose the stereo effect. In this mode, you will hear noise while tuning into the stations. The AUTO MUTING indicator goes off on the display.

Note:

When using the FM MODE button on the remote control, be sure that the 10 keys are activated for the tuner, not for the CD and others. (See page 57.)

Assigning Names to Preset Stations

You can assign a name of up to four characters to each preset station. When a preset station is tuned in, its assigned name will appear on the display.

Before you start, remember...

- There is a time limit in doing the following steps. If the setting is canceled before you finish, start from step 1 again.
- You can use the following characters: Space (), A – Z, and 0 – 9.

On the front panel ONLY:

1. Tune in a preset station.

See the left.

2. Press TUNER/SEA MEMORY.

The preset channel number starts flashing for about 10 seconds.

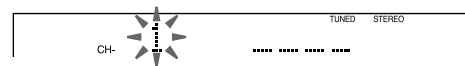
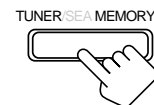

- If you turn MULTI JOG while the preset channel number is flashing, you can change the preset channel number.

3. Press TUNER PRESET, while the preset channel number is flashing.

The first character position starts flashing.

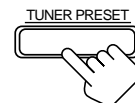

4. Turn MULTI JOG to select the first character, while the first character position is flashing.

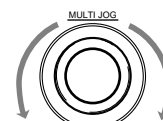
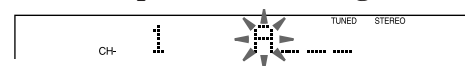

5. Press TUNER PRESET, while a character you want is flashing.

The next character position starts flashing.

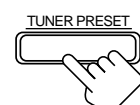

6. Repeat steps 4 and 5 to enter up to four characters.

7. Press TUNER/SEA MEMORY while the last selected character is flashing after you have assigned a name.



To erase the input characters

Insert spaces using the same procedure described above.

Using the SEA Modes

The SEA (Sound Effect Amplifier) modes give you control of the way your music sounds.

The following operations are only possible while the receiver is ready for the main room operations, and are only used for the main room sources.

IMPORTANT:

When using the buttons and controls on the front panel:

Check the following lamps' illumination.

For the main room operations:

- The MAIN ROOM ON/OFF lamp is lit.
- The SUB ROOM CONTROL lamp is not lit.

When using the remote control:

Check to see if the multi-room operation selector and the remote control mode selector are set to the correct positions:

Multi-room operation selector:

To operate this receiver for the main room, set it to "MAIN ROOM."

Remote control mode selector:

To operate this receiver, set it to "AUDIO/TV/ VCR."

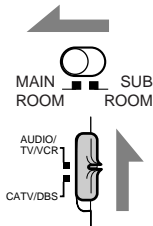

From the remote control:

1. Press SOUND.

The 10 keys are activated for sound adjustments.

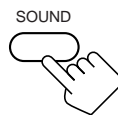

2. Press SEA MODE repeatedly until the SEA mode you want appears on the display.



To cancel the SEA mode

Press SEA MODE repeatedly until "SEA OFF" appears in step 2 above. The **SEA** indicator goes off from the display.

Creating Your Own SEA Mode

You can adjust and store your own SEA adjustment into memory (SEA USERMODE).

Before you start, remember...

- There is a time limit in doing the following steps. If the setting is canceled before you finish, start from step 1 again.

On the front panel ONLY:

If you do not want to store your adjustment, but rather want to adjust the SEA temporarily, skip step 4 below.

1. Press SEA ADJUST repeatedly until the frequency range (100Hz, 1kHz or 10kHz) you want appears on the display.

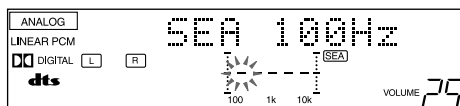

2. Turn MULTI JOG to adjust the SEA level of the selected frequency range.

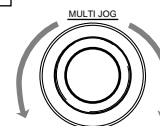

- Turning it clockwise increases the level.
- Turning it counterclockwise decreases the level.

3. Repeat steps 1 and 2 to adjust other frequency ranges if necessary.

4. Press TUNER/SEA MEMORY.

Your adjustment is stored into the SEA USERMODE.

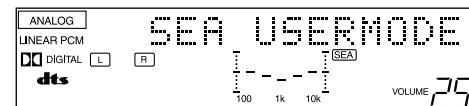

To recall your own SEA adjustment

Press SEA MODE repeatedly until "SEA USERMODE" appears.

To erase a stored adjustment

Storing a new adjustment into SEA USERMODE erases the previously stored one.

Selecting Your Favorite SEA Mode

On the front panel:

Press SEA MODE repeatedly until the SEA mode you want appears on the display.

- Each time you press the button, the SEA mode changes as follows:

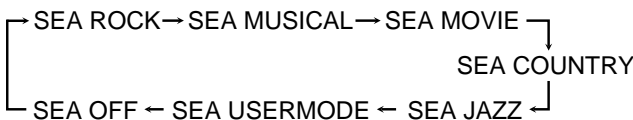

SEA ROCK:	Gives a heavy sound. Both high and low frequencies are boosted.
SEA MUSICAL:	Enhances the mid-frequency range, which the human voice is mostly made up of.
SEA MOVIE:	Adds breadth to sounds so you feel like you are in a movie theater.
SEA COUNTRY:	Enhances the high-frequency range so that instruments such the violin and banjo are emphasized.
SEA JAZZ:	Gives a feeling of a live atmosphere. Good for acoustic music.
SEA USERMODE:	Your original SEA adjustment (see the right).
SEA OFF:	No SEA mode is applied (see below).

Notes:

- The SEA modes cannot be used for recording.
- When the SEA mode is turned on, the **SEA** indicator lights up on the display.
- When the SEA mode is used with the DAP mode (see page 33), sounds may be distorted. If this happens, turn off the DAP mode or decrease the effect level of the DAP mode.

To cancel the SEA mode

Press SEA MODE repeatedly until "SEA OFF" appears. The **SEA** indicator goes off from the display.

Using the DSP Modes

The built-in Surround Processor provides three types of the DSP (Digital Signal Processor) mode — Surround mode, DAP (Digital Acoustic Processor) mode and 3D-PHONIC mode.

The following operations are only possible while the receiver is ready for the main room operations, and are only used for the main room sources.

What are the DSP Modes?

Surround modes

With this receiver, you can use three types of the Surround mode.

Following modes cannot be used when only the front speakers are connected to this receiver (without the rear speakers or center speaker).

Dolby Surround (Dolby Digital and Dolby Pro Logic)*

Used to watch the soundtracks of software encoded with Dolby Digital (bearing the mark ) or with Dolby Surround (bearing the mark ) .

Dolby Surround encoding format records the left front channel, right front channel, center channel, and rear channel (total 4 channels) signals into 2 channels. The Dolby Pro Logic decoder built in this receiver decodes these 2 channel signals into original 4 channel signals — matrix-based multichannel reproduction, and allows you to enjoy the realistic stereo sounds in your listening room.

On the other hand, Dolby Digital encoding method (the so-called discrete 5.1 channel digital audio format) records and compresses the left front channel, right front channel, center channel, left rear channel, right rear channel, and LFE channel (total 6 channels, but LFE channel is counted as 0.1 channel, therefore called 5.1 channels) signals digitally. Each channel is completely independent from other channel signals to avoid interference, therefore, you can obtain much better sound quality with much stereo and surround effects.

The Dolby Digital decoder built in this receiver can create much more realistic sound field in your listening room. You may feel as if you were in a real theater.

In addition, Dolby Digital enables stereo rear sounds, and sets the cutoff frequency of the rear treble at 20 kHz, compared to 7 kHz for Dolby Pro Logic. These facts enhance the sound movement and being-there feelings much more than Dolby Pro Logic.

- To enjoy the software encoded with Dolby Digital, you must connect the source component using the digital terminal on the rear of this receiver. (See page 9.)



DTS Digital Surround**



DTS Digital Surround is another discrete 5.1 channel digital audio format available on CD, LD, and DVD software.

Compared to Dolby Digital, audio compression rate is relatively high. This fact allows DTS Digital Surround format to have more data recorded than Dolby Digital even using the same media, and to add breadth and depth to the reproduced sounds. As a result, DTS Digital Surround features natural, solid and clear sound.

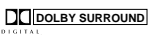
- To enjoy the software encoded with DTS Digital Surround, you must connect the source component using the digital terminal on the rear of this receiver. (See page 9.)

JVC Theater Surround

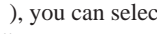
In order to reproduce a more realistic sound field in your listening room while playing soundtracks of software encoded with Dolby Digital (bearing the mark ) , with Dolby Surround (bearing the mark ) , or with DTS Digital Surround (bearing the mark ) , you can use JVC Theater Surround.

- When playing a source encoded with Dolby Surround (bearing the mark ) , you can select “LARGE THEATER” or “SMALL THEATER.”
- When playing a source encoded with Dolby Digital (bearing the mark ) , you can select “DIG L. THEATER” or “DIG S. THEATER.”
- When playing a source encoded with DTS Digital Surround (bearing the mark ) , you can select “DTS L. THEATER” or “DTS S. THEATER.”

LARGE THEATER: Reproduces the sound field of a large (**DIG L. THEATER**) theater (where the seating capacity is (**DTS L. THEATER**) almost 1,000).

SMALL THEATER: Reproduces the sound field of a small (**DIG S. THEATER**) theater (where the seating capacity is (**DTS S. THEATER**) almost 500).

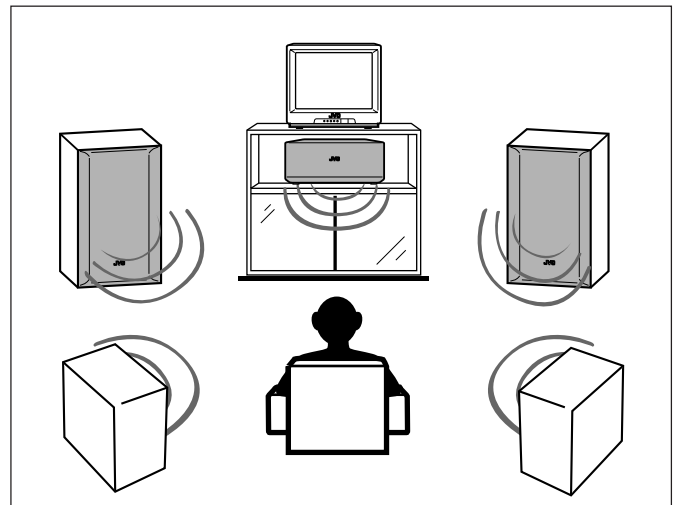



Notes:

- When the SUB ROOM ON/OFF lamp and the SUB ROOM speaker (SPEAKERS 2) lamp on the front panel are lit green, the SURROUND ON/OFF button do not work.
- When the SUB ROOM ON/OFF lamp and SUB ROOM speaker (SPEAKERS 2) lamp on the front panel are lit green, you can only use 3D-PHONIC modes and DAP modes for the main room source.
- The DSP modes have no effect on monaural sources.
- When you select “DVD MULTI” as the source to play, you cannot select or adjust the DSP modes.
- The  PRO LOGIC indicator lights up when the Dolby Pro Logic decoder built in this receiver is activated.

* Manufactured under license from Dolby Laboratories. “Dolby,” “Pro Logic,” and the double-D symbol are trademarks of Dolby Laboratories. Confidential Unpublished Works. ©1992–1997 Dolby Laboratories, Inc. All rights reserved.

** Manufactured under license from Digital Theater Systems, Inc. US Pat. No. 5,451,942 and other world-wide patents issues and pending. “DTS” and “DTS Digital Surround” are trademarks of Digital Theater Systems, Inc. ©1996 Digital Theater Systems, Inc. All rights reserved.

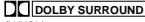
DAP modes

In order to reproduce a more acoustic sound field in your listening room while playing music sources or soundtracks of software encoded with Dolby Digital (bearing the mark ) , with Dolby Surround (bearing the mark ) , or with DTS Digital Surround (bearing the mark ) , you can use DAP modes. **This mode can be used when the front speakers are connected to this receiver (without respect to the rear/center speaker connection).**

LIVE CLUB:	Gives the close feeling of a live music club with a low ceiling.
DANCE CLUB:	Gives a powerful feeling of a dance club.
CONCERT HALL:	Gives the expansive feeling of a concert hall.
CONCERT ARENA:	Gives the spacious feeling of a large arena with a high ceiling.

3D-PHONIC modes

The 3D-PHONIC mode gives you such a nearly surround effect as is reproduced through the Dolby Surround decoder, which is widely used to reproduce sounds with a feeling of movement like those experienced in movie theaters. The 3D-PHONIC mode is the result of research on sound localization technology carried out at JVC for many years. **This mode can be used when the front speakers are connected to this receiver (without respect to the rear/center speaker connection).**

No adjustments are required for the 3D-PHONIC modes. By simply selecting one of the 3D-PHONIC modes, you can enjoy the 3D-PHONIC effect.

- You can select “3D ACTION” only when playing an analog or linear PCM (digital) source.
- You can select “3D DIGITAL” only when playing a source encoded with Dolby Digital or DTS Digital Surround.
- You can select “3D L. THEATER” and “3D S. THEATER” when only front speakers are connected to this receiver and “REAR SPK” and “CENTER SPK” are set to “NONE” (see page 24).

3D ACTION:	Best for action and war movies — where the action is fast and explosive.
3D DIGITAL:	Reproduces multichannel source encoded with Dolby Digital or with DTS Digital Surround.
3D L. (large) THEATER:	Reproduces the sound field of a large theater (where the seating capacity is about 1,000).
3D S. (small) THEATER:	Reproduces the sound field of a small theater (where the seating capacity is about 500).

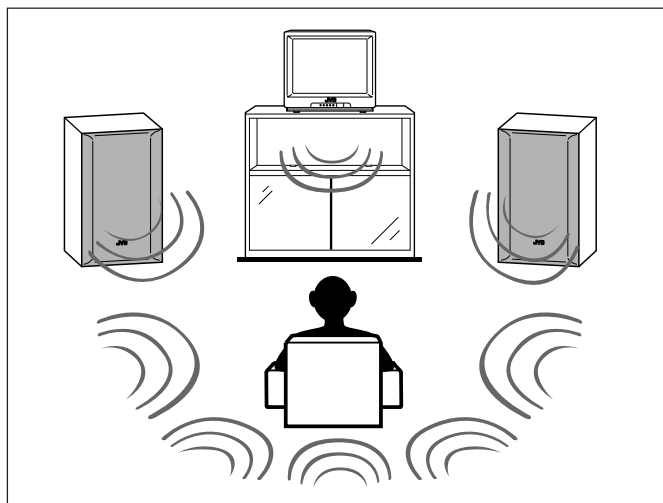

Reproducing the Sound Field

The sound heard in a concert hall or club consists of direct sound and indirect sound — early reflections and reflections from behind. Direct sounds reach the listener directly without any reflection. On the other hand, indirect sounds are delayed by the distances of the ceiling and walls. These direct sounds and indirect sounds are the most important elements of the acoustic surround effects. JVC Theater Surround, DAP modes and 3D-PHONIC modes can create these important elements, and give you a real “being there” feeling.

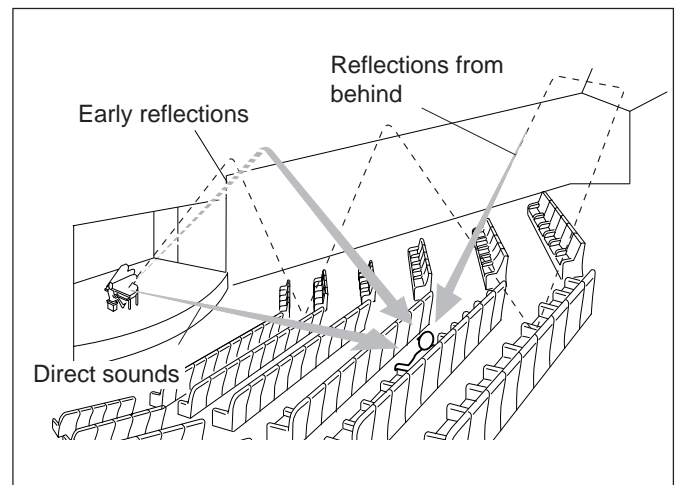

DVD MULTI Playback Mode

This receiver provides the DVD MULTI playback mode for reproducing the analog discrete 5.1 channel output mode of the DVD player or other equipment.

You can adjust the DVD MULTI playback mode while playing back a video software such as a DVD using the analog discrete 5.1 channel output mode.

- For the DVD MULTI playback mode connection, see page 8.
- For details on the DVD MULTI playback mode, see page 41.

Available DSP Modes According to the Speaker Arrangement

Available DSP modes will vary depending on how many speakers are used with this receiver.
Make sure that you have set the speaker information correctly (see page 24).

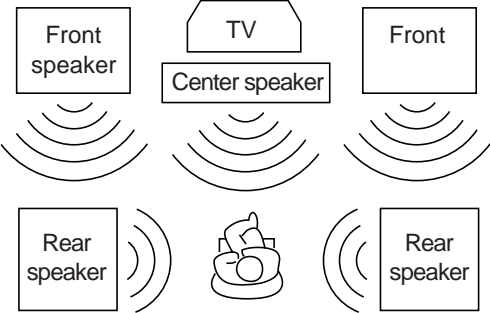
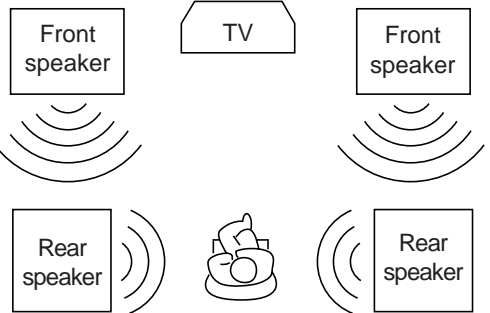
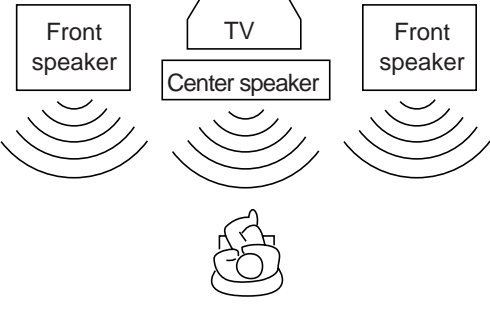
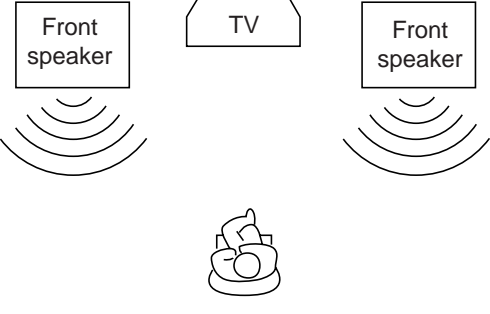
Speaker arrangements	Available DSP modes				
	<p>Each time you press DSP MODE on the front panel or SURROUND MODE on the remote control, the DSP modes change as follows:</p> <table border="0"> <tr> <td data-bbox="671 510 1025 544" style="background-color: black; color: white; text-align: center;">On the front panel</td> <td data-bbox="1063 510 1448 544" style="background-color: black; color: white; text-align: center;">On the remote control</td> </tr> <tr> <td data-bbox="671 562 1025 887"> <p>By pressing DSP MODE:</p> <ul style="list-style-type: none"> • LARGE THEATER (or DIG L. THEATER*, DTS L. THEATER**) • SMALL THEATER (or DIG S. THEATER*, DTS S. THEATER**) • LIVE CLUB • DANCE CLUB • CONCERT HALL • CONCERT ARENA • 3D ACTION (or 3D DIGITAL) • DSP OFF (DSP mode is canceled) </td> <td data-bbox="1063 562 1448 976"> <p>By pressing SURROUND MODE:</p> <ul style="list-style-type: none"> • SURROUND ON (PRO LOGIC, DOLBY DIGITAL*, or DTS SURROUND**) • LARGE THEATER (or DIG L. THEATER*, DTS L. THEATER**) • SMALL THEATER (or DIG S. THEATER*, DTS S. THEATER**) • LIVE CLUB • DANCE CLUB • CONCERT HALL • CONCERT ARENA • 3D ACTION (or 3D DIGITAL) • DSP OFF (DSP mode is canceled) </td> </tr> </table> <div data-bbox="675 913 1031 1055" style="border: 1px solid black; padding: 5px; margin-top: 10px;"> <p>To activate the Surround mode, press SURROUND ON/OFF button so that the lamp on the button lights up.</p> </div> <div data-bbox="1063 992 1448 1115" style="border: 1px solid black; padding: 5px; margin-top: 10px;"> <p>To activate the Surround mode, you can also use the SURROUND ON/OFF button.</p> </div>	On the front panel	On the remote control	<p>By pressing DSP MODE:</p> <ul style="list-style-type: none"> • LARGE THEATER (or DIG L. THEATER*, DTS L. THEATER**) • SMALL THEATER (or DIG S. THEATER*, DTS S. THEATER**) • LIVE CLUB • DANCE CLUB • CONCERT HALL • CONCERT ARENA • 3D ACTION (or 3D DIGITAL) • DSP OFF (DSP mode is canceled) 	<p>By pressing SURROUND MODE:</p> <ul style="list-style-type: none"> • SURROUND ON (PRO LOGIC, DOLBY DIGITAL*, or DTS SURROUND**) • LARGE THEATER (or DIG L. THEATER*, DTS L. THEATER**) • SMALL THEATER (or DIG S. THEATER*, DTS S. THEATER**) • LIVE CLUB • DANCE CLUB • CONCERT HALL • CONCERT ARENA • 3D ACTION (or 3D DIGITAL) • DSP OFF (DSP mode is canceled)
On the front panel	On the remote control				
<p>By pressing DSP MODE:</p> <ul style="list-style-type: none"> • LARGE THEATER (or DIG L. THEATER*, DTS L. THEATER**) • SMALL THEATER (or DIG S. THEATER*, DTS S. THEATER**) • LIVE CLUB • DANCE CLUB • CONCERT HALL • CONCERT ARENA • 3D ACTION (or 3D DIGITAL) • DSP OFF (DSP mode is canceled) 	<p>By pressing SURROUND MODE:</p> <ul style="list-style-type: none"> • SURROUND ON (PRO LOGIC, DOLBY DIGITAL*, or DTS SURROUND**) • LARGE THEATER (or DIG L. THEATER*, DTS L. THEATER**) • SMALL THEATER (or DIG S. THEATER*, DTS S. THEATER**) • LIVE CLUB • DANCE CLUB • CONCERT HALL • CONCERT ARENA • 3D ACTION (or 3D DIGITAL) • DSP OFF (DSP mode is canceled) 				
	<p>To activate the Surround mode, press SURROUND ON/OFF button so that the lamp on the button lights up.</p> <p>To activate the Surround mode, you can also use the SURROUND ON/OFF button.</p>				
	<p>* Activated automatically only when the digital input is selected and playback source is encoded with Dolby Digital.</p> <p>** Activated automatically only when the digital input is selected and playback source is encoded with DTS Digital Surround.</p> <p>Note:</p> <p>If Surround mode is canceled while playing back a multichannel source such as Dolby Digital and DTS Digital Surround, all channel signals are mixed with left and right front channel and are output through the front speakers.</p>				
	<p>Each time you press DSP MODE on the front panel or SURROUND MODE on the remote control, the DSP modes change as follows:</p> <ul style="list-style-type: none"> • 3D L. (large) THEATER • 3D S. (small) THEATER • LIVE CLUB • DANCE CLUB • CONCERT HALL • CONCERT ARENA • 3D ACTION (or 3D DIGITAL) • DSP OFF (DSP mode is canceled) 				

When the SUB ROOM ON/OFF lamp and SUB ROOM speaker (SPEAKERS 2) lamp on the front panel are lit green
 You can only use 3D-PHONIC modes and DAP modes for the main room source, without respect to the center/rear speaker connection.

IMPORTANT:

When using the buttons and controls on the front panel:

Check the following lamps' illumination.

For the main room operations:

- The MAIN ROOM ON/OFF lamp is lit.
- The SUB ROOM CONTROL lamp is not lit.

When using the remote control:

Check to see if the multi-room operation selector and the remote control mode selector are set to the correct positions:

Multi-room operation selector:

To operate this receiver for the main room, set it to "MAIN ROOM."

Remote control mode selector:

To operate this receiver, set it to "AUDIO/TV/ VCR."

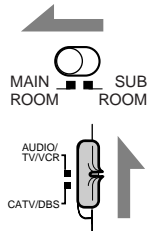

Adjusting the Surround Modes

Once you have adjusted the Surround modes, the adjustment is memorized for each Surround mode.

Dolby and DTS Surround adjustments

Before you start, remember...

- Make sure that you have set the speaker information correctly (see page 24).
- There is a time limit in doing the following steps. If the setting is canceled before you finish, start from step 1 again.
- You cannot adjust the rear speaker output levels and rear tone when you have set "REAR SPK" to "NONE." See page 24.
- You cannot adjust the center speaker output level and center tone when you have set "CENTER SPK" to "NONE." See page 24.

From the remote control:

1. Press SURROUND ON/OFF to activate an appropriate Surround mode — PRO LOGIC, DOLBY DIGITAL or DTS SURROUND.



- Each time you press the button, the Surround mode turns on and off alternately.
- When "PRO LOGIC" is selected, the PRO LOGIC indicator lights up on the display.

Note:

You can also press SURROUND MODE to activate an appropriate Surround mode.

2. Press SOUND.

The 10 keys are activated for sound adjustments.

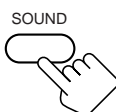

3. Press TEST to check the speaker output balance.

"TEST TONE L" starts flashing on the display, and a test tone comes out of the speakers in the following order:

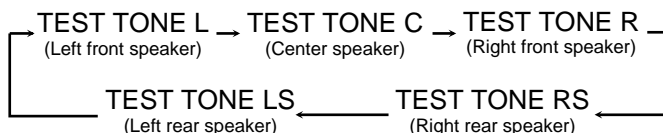

Notes:

- You can adjust the speaker output levels without outputting the test tone.
- No test tone comes out of the center speaker when "CENTER SPK" is set to "NONE" (see page 24).
- No test tone comes out of the rear speakers when "REAR SPK" is set to "NONE" (see page 24).
- If the TV is turned on and the proper video input is selected on the TV, the test tone screen will appear on the TV.

4. Adjust the speaker output levels.

- To adjust the center speaker level, press CENTER +/- (from -10 dB to +10 dB).
- To adjust the left rear speaker level, press REAR•L +/- (from -10 dB to +10 dB).
- To adjust the right rear speaker level, press REAR•R +/- (from -10 dB to +10 dB).

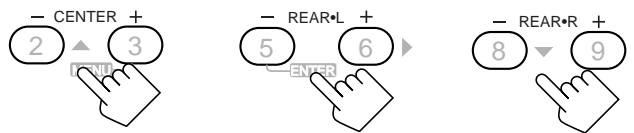

5. Press TEST again to stop the test tone.



6. Press CNTR TONE to select the center tone level you want.

The center tone adjustment affects the mid-frequency range, which the human voice is mostly made up of.

- Each time you press the button, the display changes to show the following:

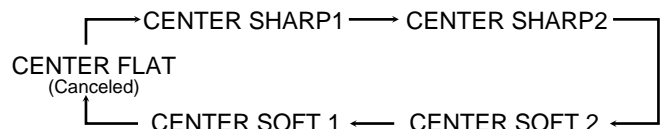

To make the dialogue clearer, select "CENTER SHARP1" (a little) or "CENTER SHARP2" (much).

To make the dialogue softer, select "CENTER SOFT 1" (a little) or "CENTER SOFT 2" (much).

When "CENTER FLAT" is selected, no adjustment is applied.

7. Press REAR TONE to select the rear tone level you want.

- Each time you press the button, the display changes to show the following:

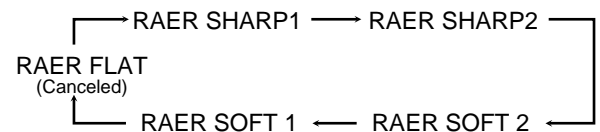

To make the rear sounds clearer, select "REAR SHARP1" (a little) or "REAR SHARP2" (much).

To make the rear sounds softer, select "REAR SOFT 1" (a little) or "REAR SOFT 2" (much).

When "REAR FLAT" is selected, no adjustment is applied.

On the front panel:

You can also use the buttons on the front panel to adjust the Surround modes. However, no test tone is available when using the buttons on the front panel. So, make adjustments while listening to the sound of the source played back.

1. Press SURROUND ON/OFF to activate an appropriate Surround mode — PRO LOGIC, DOLBY DIGITAL or DTS SURROUND.



- Each time you press the button, the Surround mode turns on and off alternately.
- When “PRO LOGIC” is selected, the  PRO LOGIC indicator lights up on the display.

2. Adjust the speaker output levels.

- 1) Press **BALANCE/SURROUND ADJUST** repeatedly until one of the indications appears on the display.
“CENTER LEVEL”:



- To adjust the center speaker level.
- “REAR L LEVEL”:
To adjust the left rear speaker level.
- “REAR R LEVEL”:
To adjust the right rear speaker level.

- 2) Turn **MULTI JOG** to adjust the selected speaker output level (from -10 dB to $+10$ dB).
- 3) Repeat 1) and 2) to adjust the other speaker output levels.

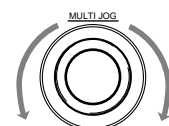

3. Adjust the center tone.

- 1) Press **BALANCE/SURROUND ADJUST** repeatedly until “CENTER TONE” appears on the display.
The display changes to show the current setting.
- 2) Turn **MULTI JOG** to select the center tone level you want.
 - As you turn it, the display changes to show the following:

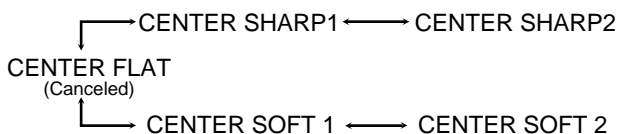
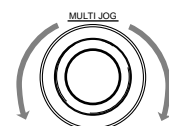

- To make the dialogue clearer, select “CENTER SHARP1” (a little) or “CENTER SHARP2” (much).
- To make the dialogue softer, select “CENTER SOFT 1” (a little) or “CENTER SOFT 2” (much).
- When “CENTER FLAT” is selected, no adjustment is applied.

4. Adjust the rear tone.

- 1) Press **BALANCE/SURROUND ADJUST** repeatedly until “REAR TONE” appears on the display.
The display changes to show the current setting.
- 2) Turn **MULTI JOG** to select the rear tone level you want.
 - As you turn it, the display changes to show the following:

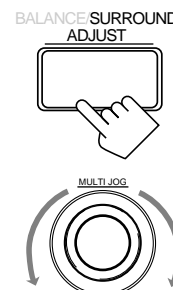

- To make the rear sounds clearer, select “REAR SHARP1” (a little) or “REAR SHARP2” (much).
- To make the rear sounds softer, select “REAR SOFT 1” (a little) or “REAR SOFT 2” (much).
- When “REAR FLAT” is selected, no adjustment is applied.

JVC Theater Surround adjustments

Before you start, remember...

- Make sure that you have set the speaker information correctly (see page 24).
- There is a time limit in doing the following steps. If the setting is canceled before you finish, start from step 1 again.
- You cannot adjust the rear speaker output levels and rear tone when you have set “REAR SPK” to “NONE.” See page 24.
- You cannot adjust the center speaker output level and center tone when you have set “CENTER SPK” to “NONE.” See page 24.

On the front panel:

You can also use the buttons on the front panel to adjust the Surround modes. However, no test tone is available when using the buttons on the front panel. So, make adjustments while listening to the sound of the source played back.

1. Press **DSP MODE** repeatedly until “LARGE THEATER (or DIG L. THEATER, DTS L. THEATER)” or “SMALL THEATER (or DIG S. THEATER, DTS S. THEATER)” appears on the display.

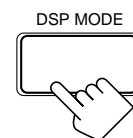

2. Adjust the speaker output levels.

- 1) Press **BALANCE/SURROUND ADJUST** repeatedly until one of the indications appears on the display.
“CENTER LEVEL”:
To adjust the center speaker level.
“REAR L LEVEL”:
To adjust the left rear speaker level.
“REAR R LEVEL”:
To adjust the right rear speaker level.
- 2) Turn **MULTI JOG** to adjust the selected speaker output level (from -10 dB to $+10$ dB).

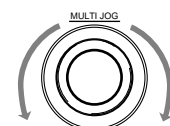

- Repeat 1) and 2) to adjust the other speaker output levels.

3. Adjust the center tone.

- Press **BALANCE/SURROUND ADJUST** repeatedly until **"CENTER TONE"** appears on the display.
The display changes to show the current setting.
- Turn **MULTI JOG** to select the center tone level you want.
 - As you turn it, the display changes to show the following:

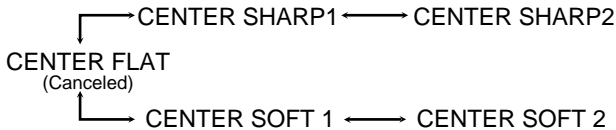
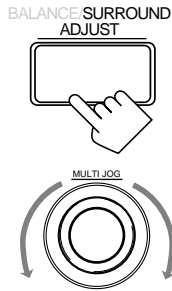

To make the dialogue clearer, select "CENTER SHARP1" (a little) or "CENTER SHARP2" (much).

To make the dialogue softer, select "CENTER SOFT 1" (a little) or "CENTER SOFT 2" (much).

When "CENTER FLAT" is selected, no adjustment is applied.

4. Adjust the rear tone.

- Press **BALANCE/SURROUND ADJUST** repeatedly until **"REAR TONE"** appears on the display.
The display changes to show the current setting.
- Turn **MULTI JOG** to select the rear tone level you want.
 - As you turn it, the display changes to show the following:

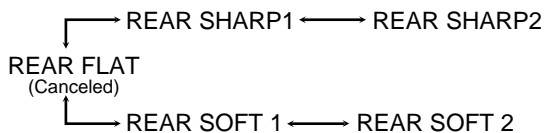
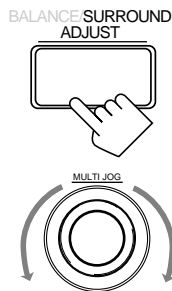

To make the rear sounds clearer, select "REAR SHARP1" (a little) or "REAR SHARP2" (much).

To make the rear sounds softer, select "REAR SOFT 1" (a little) or "REAR SOFT 2" (much).

When "REAR FLAT" is selected, no adjustment is applied.

5. Adjust the overall level of the effects.

- Press **BALANCE/SURROUND ADJUST** repeatedly until **"EFFECT LEVEL"** appears on the display.
The display changes to show the current setting.
- Turn **MULTI JOG** to select the effect level.
 - As you turn it, the effect level changes as follows:

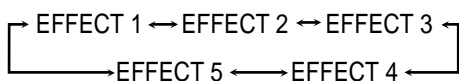
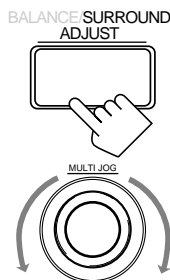

As the number increases, the overall level of reflections applied to the direct sounds increases. (Normally set it to "EFFECT 3.")

6. Adjust the room size (sense of spaciousness).

- Press **BALANCE/SURROUND ADJUST** repeatedly until **"ROOM SIZE"** appears on the display.
The display changes to show the current setting.
- Turn **MULTI JOG** to select the room size.
 - As you turn it, the room size changes as follows:

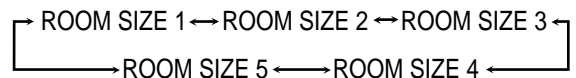
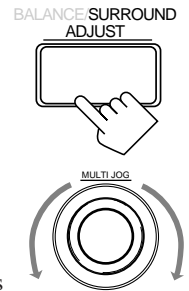

As the number increases, the interval between reflections increases so that you will feel as if you were in a larger room. (Normally set it to "ROOM SIZE 3.")

7. Adjust the liveness.

- Press **BALANCE/SURROUND ADJUST** repeatedly until **"LIVENESS"** appears on the display.
The display changes to show the current setting.
- Turn **MULTI JOG** to select the liveness effect.
 - As you turn it, the liveness level changes as follows:

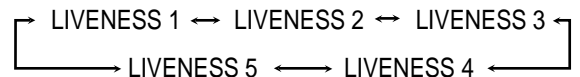
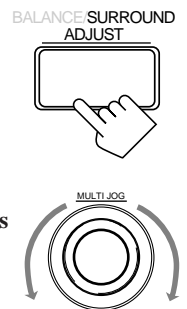

As the number increases, the attenuation level of reflections over time decreases so that acoustics change from "Dead" to "Live." (Normally set it to "LIVENESS 3.")

From the remote control:

When using the remote control, you cannot adjust the effect level, room size, and liveness. To adjust these parameters, use the buttons and controls on the front panel.

- Press **SURROUND MODE** repeatedly until **"LARGE THEATER (or DIG L. THEATER, DTS L. THEATER)"** or **"SMALL THEATER (or DIG S. THEATER, DTS S. THEATER)"** appears on the display.



- Press **SOUND**.

The 10 keys are activated for sound adjustments.

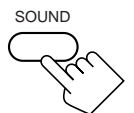

- Press **TEST** to check the speaker output balance.

"TEST TONE L" starts flashing on the display, and a test tone comes out of the speakers in the following order:

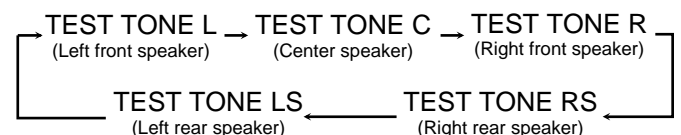

Continued to the next page.

Notes:

- You can adjust the speaker output levels without outputting the test tone.
- No test tone comes out of the center speaker when “CENTER SPK” is set to “NONE” (see page 24).
- No test tone comes out of the rear speakers when “REAR SPK” is set to “NONE” (see page 24).
- If the TV is turned on and the proper video input is selected on the TV, the test tone screen will appear on the TV.

4. Adjust the speaker output levels.

- To adjust the center speaker level, press CENTER +/- (from -10 dB to +10 dB).
- To adjust the left rear speaker level, press REAR•L +/- (from -10 dB to +10 dB).
- To adjust the right rear speaker level, press REAR•R +/- (from -10 dB to +10 dB).

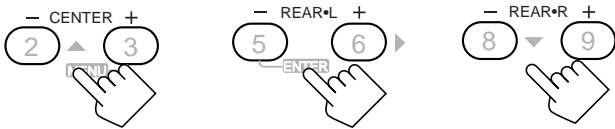

5. Press TEST again to stop the test tone.



6. Press CNTR TONE to select the center tone level you want.



The center tone adjustment affects the mid-frequency range, which the human voice is mostly made up of.

- Each time you press the button, the display changes to show the following:

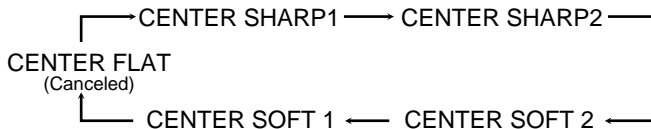

To make the dialogue clearer, select “CENTER SHARP1” (a little) or “CENTER SHARP2” (much).

To make the dialogue softer, select “CENTER SOFT 1” (a little) or “CENTER SOFT 2” (much).

When “CENTER FLAT” is selected, no adjustment is applied.

7. Press REAR TONE to select the rear tone level you want.



- Each time you press the button, the display changes to show the following:

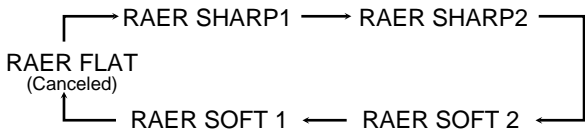

To make the rear sounds clearer, select “REAR SHARP1” (a little) or “REAR SHARP2” (much).

To make the rear sounds softer, select “REAR SOFT 1” (a little) or “REAR SOFT 2” (much).

When “REAR FLAT” is selected, no adjustment is applied.

8. Adjust the effect level, room size, and liveness by using the buttons and controls on the front panel.

Adjusting the DAP Modes

Once you have adjusted the DAP modes, the adjustment is memorized for each DAP mode.

Before you start, remember...

- Make sure that you have set the speaker information correctly (see page 24).
- There is a time limit in doing the following steps. If the setting is canceled before you finish, start from step 1 again.
- You cannot adjust the rear speaker output level and rear tone when you have set “REAR SPK” to “NONE” (see page 24) and when the SUB ROOM ON/OFF lamp and the SUB ROOM speaker (SPEAKERS 2) lamp on the front panel are lit green.
- When the DAP mode is used with the SEA mode (see page 31), sounds may be distorted. If this happens, turn off the SEA mode.

On the front panel:

1. Press DSP MODE repeatedly until the DAP mode — LIVE CLUB, DANCE CLUB, CONCERT HALL, or CONCERT ARENA — appears on the display.



The DSP indicator also lights up on the display.

- When you have set “REAR SPK” to “NONE,” the 3D-PHONIC indicator also lights up.

2. Adjust the speaker output levels.

- 1) Press BALANCE/SURROUND ADJUST repeatedly until one of the indications appears on the display.



“REAR L LEVEL”:

To adjust the left rear speaker level.

“REAR R LEVEL”:

To adjust the right rear speaker level.

- 2) Turn MULTI JOG to adjust the selected speaker output level (from -10 dB to +10 dB).

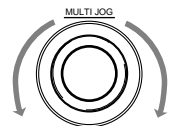

- 3) Repeat 1) and 2) to adjust the other speaker output level.

3. Adjust the rear tone.

- 1) Press BALANCE/SURROUND ADJUST repeatedly until “REAR TONE” appears on the display.



The display changes to show the current setting.

- 2) Turn MULTI JOG to select the rear tone level you want.

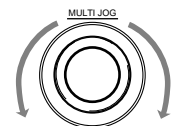

- As you turn it, the display changes to show the following:

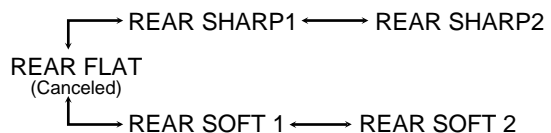

To make the rear sounds clearer, select “REAR SHARP1” (a little) or “REAR SHARP2” (much).

To make the rear sounds softer, select “REAR SOFT 1” (a little) or “REAR SOFT 2” (much).

When “REAR FLAT” is selected, no adjustment is applied.

4. Adjust the overall level of the effects.

- 1) Press **BALANCE/SURROUND ADJUST** repeatedly until **"EFFECT LEVEL"** appears on the display. The display changes to show the current setting.



- 2) Turn **MULTI JOG** to select the effect level.

- As you turn it, the effect level changes as follows:

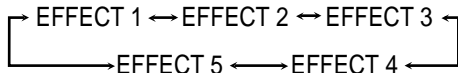

As the number increases, the overall level of reflections applied to the direct sounds increases. (Normally set it to "EFFECT 3.")

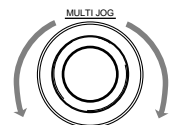

5. Adjust the room size (sense of spaciousness).

- 1) Press **BALANCE/SURROUND ADJUST** repeatedly until **"ROOM SIZE"** appears on the display. The display changes to show the current setting.



- 2) Turn **MULTI JOG** to select the room size.

- As you turn it, the room size changes as follows:

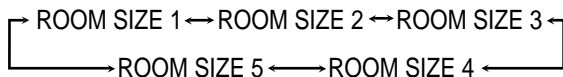

As the number increases, the interval between reflections increases so that you will feel as if you were in a larger room. (Normally set it to "ROOM SIZE 3.")

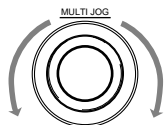

6. Adjust the liveness.

- 1) Press **BALANCE/SURROUND ADJUST** repeatedly until **"LIVENESS"** appears on the display. The display changes to show the current setting.



- 2) Turn **MULTI JOG** to select the liveness effect.

- As you turn it, the liveness level changes as follows:

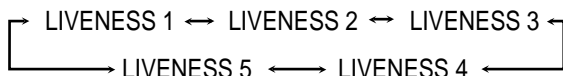

As the number increases, the attenuation level of reflections over time decreases so that acoustics change from "Dead" to "Live." (Normally set it to "LIVENESS 3.")

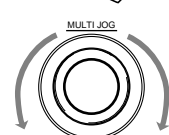

From the remote control:

When using the remote control, you cannot adjust the effect level, room size, and liveness. To adjust these parameters, use the buttons and controls on the front panel.

1. Press **SURROUND MODE** repeatedly until the **DAP mode** — **LIVE CLUB, DANCE CLUB, CONCERT HALL, or CONCERT ARENA** — appears on the display.



The DSP indicator also lights up on the display.

- When you have set "REAR SPK" to "NONE," the 3D-PHONIC indicator also lights up.

2. Press **SOUND**.

The 10 keys are activated for sound adjustments.

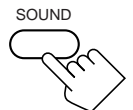

3. Adjust the speaker output levels.

- To adjust the left rear speaker level, press **REAR•L** +/- (from -10 dB to +10 dB).
- To adjust the right rear speaker level, press **REAR•R** +/- (from -10 dB to +10 dB).

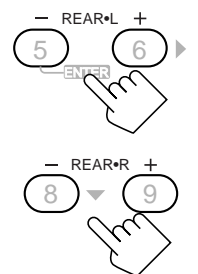

4. Press **REAR TONE** to select the rear tone level you want.

- Each time you press the button, the display changes to show the following:

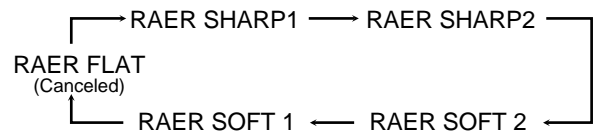

To make the rear sounds clearer, select "REAR SHARP1" (a little) or "REAR SHARP2" (much).

To make the rear sounds softer, select "REAR SOFT 1" (a little) or "REAR SOFT 2" (much).

When "REAR FLAT" is selected, no adjustment is applied.

5. Adjust the effect level, room size, and liveness by using the buttons and controls on the front panel.

Activating the DSP Modes

You can use only one DSP mode at a time. When a DSP mode is activated, another DSP mode is canceled if in use.

For Dolby Pro Logic, Dolby Digital, and DTS Digital Surround

1. Press SURROUND ON/OFF so that the lamp on the front panel button lights up.

- Each time you press the button, the Dolby/DTS Surround turns on and off alternately.

SURROUND ON/OFF

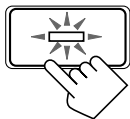



On the front panel

SURROUND

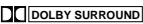

On the remote control

2. Select and play a sound source.

- To enjoy Dolby Pro Logic, play back a software encoded with Dolby Surround and labeled with  mark.
- To enjoy Dolby Digital, play back a software encoded with Dolby Digital and labeled with  mark.
- To enjoy DTS Digital Surround, play back a software encoded with DTS Digital Surround and labeled with  mark.

To cancel the Dolby/DTS Surround mode

Press SURROUND ON/OFF again so that the lamp on the front panel button goes off. (“SURROUND OFF” appears on the display.)

SURROUND ON/OFF

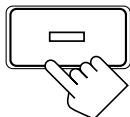

On the front panel

SURROUND



On the remote control

For the other DSP modes



On the front panel:

1. Press DSP MODE repeatedly until the mode you want appears on the display.

- Each time you press the button, the DSP modes change. (See page 34 for more details.)

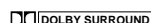

2. Select and play a sound source.

- To enjoy 3D-PHONIC and JVC Theater Surround, play back a software:
 - encoded with Dolby Surround and labeled with  mark.
 - encoded with Dolby Digital and labeled with  mark.
 - encoded with DTS Digital Surround and labeled with  mark.

To cancel the DSP mode

Press DSP MODE repeatedly until “DSP OFF” appears on the display.





From the remote control:

1. Press SURROUND MODE repeatedly until the DSP mode you want appears on the display.

- Each time you press the button, the DSP modes change.

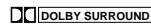

2. Select and play a sound source.

- To enjoy 3D-PHONIC and JVC Theater Surround, play back a software:
 - encoded with Dolby Surround and labeled with  mark.
 - encoded with Dolby Digital and labeled with  mark.
 - encoded with DTS Digital Surround and labeled with  mark.

To cancel the DSP mode

Press SURROUND MODE repeatedly until “DSP OFF” appears on the display.



Using the DVD MULTI Playback Mode

This receiver provides the DVD MULTI playback mode for reproducing the analog discrete output mode of the DVD player. Before playing back a DVD, refer also to the manual supplied with the DVD player.

The following operations are only possible while the receiver is ready for the main room operations, and are only used for the main room source — DVD MULTI.

IMPORTANT:

When using the buttons and controls on the front panel:

Check the following lamps' illumination.

For the main room operations:

- The MAIN ROOM ON/OFF lamp is lit.
- The SUB ROOM CONTROL lamp is not lit.

When using the remote control:

Check to see if the multi-room operation selector and the remote control mode selector are set to the correct positions:

• Multi-room operation selector:

To operate this receiver for the main room, set it to "MAIN ROOM."

• Remote control mode selector:

To operate this receiver, set it to "AUDIO/TV/VCR."

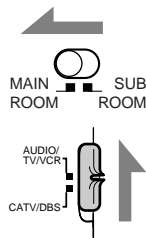

If you need to make any adjustment, go to the following steps.

3. Adjust the speaker output levels.

- 1) Press **BALANCE/SURROUND ADJUST** repeatedly until one of the indications appears on the display.

"CENTER LEVEL":

To adjust the center speaker level.

"REAR L LEVEL":

To adjust the left rear speaker level.

"REAR R LEVEL":

To adjust the right rear speaker level.

- 2) Turn **MULTI JOG** to adjust the selected speaker output level (from -10 dB to +10 dB).

- 3) Repeat 1) and 2) to adjust the other speaker output levels.

BALANCE SURROUND
ADJUST

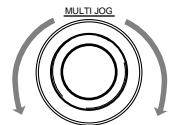

Activating the DVD MULTI Playback Mode

You can adjust the DVD MULTI playback mode while playing back a DVD using the analog discrete output mode on the DVD player. Once you have made adjustments, the receiver memorizes the adjustments until you change them. You also need to set the DVD player to the analog discrete output mode.

Before you start, remember...

- There is a time limit in doing the following steps. If the setting is canceled before you finish, start from step 1 again.

On the front panel:

1. Turn **SOURCE SELECTOR** until "DVD MULTI" appears on the display.

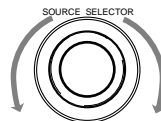

Notes:

- When you select "DVD MULTI" as the main room source to play, the DSP mode is canceled temporarily, and the SURROUND ON/OFF and DSP MODE buttons do not work.
- When the SUB ROOM ON/OFF lamp and the SUB ROOM speaker (SPEAKERS 2) lamp on the front panel are lit green, you cannot select "DVD MULTI" as the main room source.

2. Select the analog discrete output mode on the DVD player, and start playing a DVD.

- Refer to the manual supplied with the DVD player.

From the remote control:

1. Press **DVD MULTI** so that "DVD MULTI" appears on the display.



Notes:

- When you select "DVD MULTI" as the main room source to play, the DSP mode is canceled temporarily, and the SURROUND ON/OFF and DSP MODE buttons do not work.
- When the SUB ROOM ON/OFF lamp and the SUB ROOM speaker (SPEAKERS 2) lamp on the front panel are lit green, you cannot select "DVD MULTI" as the main room source.

2. Select the analog discrete output mode on the DVD player, and start playing a DVD.

- Refer to the manual supplied with the DVD player.

If you need to make any adjustment, go to the following steps.

3. Press **SOUND**.

The 10 keys are activated for adjusting the sound.

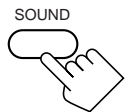

4. Adjust the speaker output levels.

- To adjust the center speaker level, press **CENTER +/-** (from -10 dB to +10 dB).
- To adjust the left rear speaker level, press **REAR•L +/-** (from -10 dB to +10 dB).
- To adjust the right rear speaker level, press **REAR•R +/-** (from -10 dB to +10 dB).

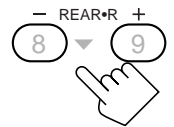
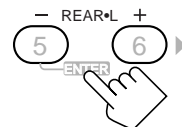
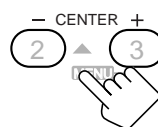

Using the On-Screen Menus

You can use the Menus on the TV screen to control the receiver.

To use this function, you need to connect the TV to the MONITOR OUT jack on the rear panel (see page 8), and set the TV's input mode to the proper position to which the receiver is connected.

- When the TV's input mode is incorrect; for example, a different video input or TV tuner mode is selected, you cannot show the Menus on the TV screen.

The following operations are only possible while the receiver is ready for the main room operations, and are used for the main room sources.

IMPORTANT:

When using the remote control:

Check to see if the multi-room operation selector and the remote control mode selector are set to the correct position:

- **Multi-room operation selector:**
To operate this receiver for the main room, set it to "MAIN ROOM."
- **Remote control mode selector:**
To operate this receiver, set it to "AUDIO/TV/ VCR."

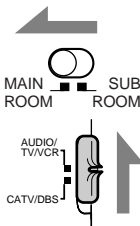

On-Screen Operation buttons (on the remote control)

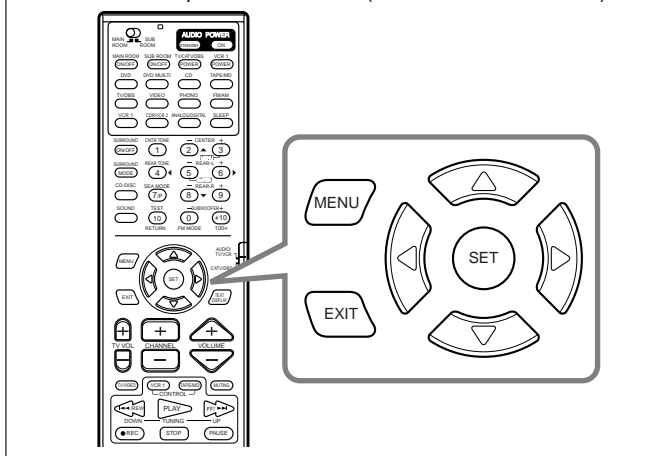

Selecting the Main Room Source to Play (Also see page 16)

1. Press MENU.

The MAIN MENU appears on the TV.

- Pressing one of the Δ / ∇ / \triangleleft / \triangleright buttons also displays the MAIN MENU.

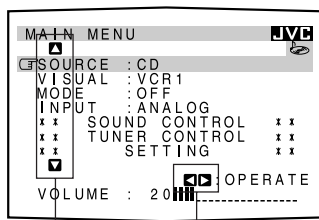

Shows the buttons you can use on the current menu. In this case, use Δ / ∇ to move \square up and down, and \triangleleft / \triangleright to select, adjust or set the item.

Notes:

- "INPUT" appears only when the digital input (DIGITAL IN) terminal setting has been correctly done for the digital source currently selected. (See page 26.)
- The on-screen display will disappear if no operation is done for about 1 minute.

2. Press Δ / ∇ to move \square to "SOURCE."

3. Press \triangleleft / \triangleright to select the source.

4. When you finish, press EXIT.

The menu disappears from the TV.

Selecting Different Sources for Picture and Sound (Also see page 17)

1. Press MENU.

The MAIN MENU appears on the TV.

- Pressing one of the Δ / ∇ / \triangleleft / \triangleright buttons also displays the MAIN MENU.

2. Press Δ / ∇ to move \square to "VISUAL."

3. Press \triangleleft / \triangleright to select a different video source.

4. When you finish, press EXIT.

The menu disappears from the TV.

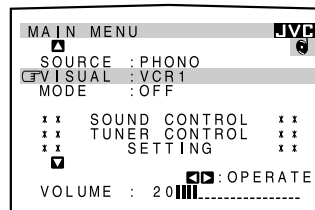

Activating the DSP Modes (Also see page 40)

1. Press MENU.

The MAIN MENU appears on the TV.

- Pressing one of the Δ / ∇ / \triangleleft / \triangleright buttons also displays the MAIN MENU.

2. Press Δ / ∇ to move \square to "MODE."

3. Press \triangleleft / \triangleright to select the DSP mode you want to use.

4. When you finish, press EXIT.

The menu disappears from the TV.

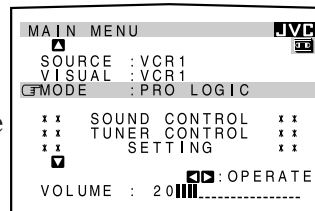

Selecting the Analog or Digital Input Mode (Also see page 26)

This selection is only possible when the digital input (DIGITAL IN) terminal setting has been correctly done for the digital source currently selected.

1. Press MENU.

The MAIN MENU appears on the TV.

- Pressing one of the Δ / ∇ / \triangleleft / \triangleright buttons also displays the MAIN MENU.

2. Press Δ / ∇ to move \square to "INPUT."

3. Press \triangleleft / \triangleright to select the digital or analog input you want.

For details, see page 27.

4. When you finish, press EXIT.

The menu disappears from the TV.

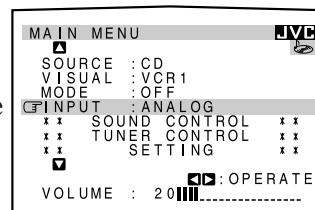

■ Adjusting the Front Speaker Output Balance (Also see page 19)

1. Press MENU.

The MAIN MENU appears on the TV.

- Pressing one of the Δ / ∇ / \triangleleft / \triangleright buttons also displays the MAIN MENU.

2. Press Δ / ∇ to move \mathbb{F} to “SOUND CONTROL,” then press \triangleleft / \triangleright .

The SOUND CONTROL menu appears.

- “SURROUND LEVEL” and “SURROUND EFFECT” appear on the display only when one of the DAP and Surround modes is selected.

3. Press Δ / ∇ to move \mathbb{F} to “BAL.” (Balance).

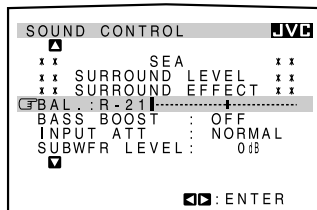

4. Press \triangleleft / \triangleright to adjust the balance.

5. When you finish, press EXIT repeatedly until the menu disappears from the TV.

■ Reinforcing the Bass (Also see page 18)

1. Press MENU.

The MAIN MENU appears on the TV.

- Pressing one of the Δ / ∇ / \triangleleft / \triangleright buttons also displays the MAIN MENU.

2. Press Δ / ∇ to move \mathbb{F} to “SOUND CONTROL,” then press \triangleleft / \triangleright .

The SOUND CONTROL menu appears.

- “SURROUND LEVEL” and “SURROUND EFFECT” appear on the display only when one of the DAP and Surround modes is selected.

3. Press Δ / ∇ to move \mathbb{F} to “BASS BOOST.”

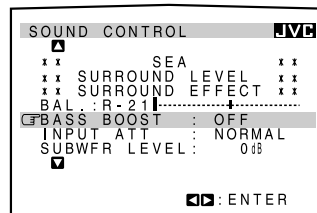

4. Press \triangleleft / \triangleright to turn the bass boost function “ON” or “OFF.”

5. When you finish, press EXIT repeatedly until the menu disappears from the TV.

■ Attenuating the Input Signal (Also see page 18)

1. Press MENU.

The MAIN MENU appears on the TV.

- Pressing one of the Δ / ∇ / \triangleleft / \triangleright buttons also displays the MAIN MENU.

2. Press Δ / ∇ to move \mathbb{F} to “SOUND CONTROL,” then press \triangleleft / \triangleright .

The SOUND CONTROL menu appears.

- “SURROUND LEVEL” and “SURROUND EFFECT” appear on the display only when one of the DAP and Surround modes is selected.

3. Press Δ / ∇ to move \mathbb{F} to “INPUT ATT.”

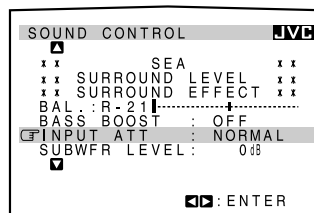

4. Press \triangleleft / \triangleright to turn the Input Attenuator mode “ATT ON” or “NORMAL.”

5. When you finish, press EXIT repeatedly until the menu disappears from the TV.

■ Adjusting the Subwoofer Output Level (Also see page 18)

1. Press MENU.

The MAIN MENU appears on the TV.

- Pressing one of the Δ / ∇ / \triangleleft / \triangleright buttons also displays the MAIN MENU.

2. Press Δ / ∇ to move \mathbb{F} to “SOUND CONTROL,” then press \triangleleft / \triangleright .

The SOUND CONTROL menu appears.

- “SURROUND LEVEL” and “SURROUND EFFECT” appear on the display only when one of the DAP and Surround modes is selected.

3. Press Δ / ∇ to move \mathbb{F} to “SUBWFR LEVEL.”

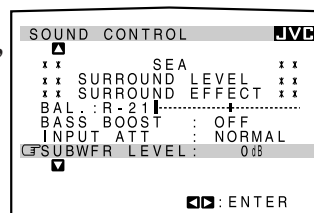

4. Press \triangleleft / \triangleright to adjust the subwoofer output level.

5. When you finish, press EXIT repeatedly until the menu disappears from the TV.

■ Adjusting the DSP Modes (Also see pages 35 – 39)

1. Press MENU.

The MAIN MENU appears on the TV.

- Pressing one of the Δ / ∇ / \triangleleft / \triangleright buttons also displays the MAIN MENU.

2. Press Δ / ∇ to move \mathbb{F} to “MODE.”

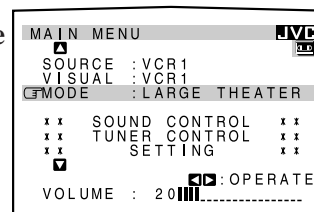

3. Press \triangleleft / \triangleright to select the DSP mode you want to adjust.

- In this example, “LARGE THEATER” is selected.

4. Press Δ / ∇ to move \mathbb{F} to “SOUND CONTROL,” then press \triangleleft / \triangleright .

The SOUND CONTROL menu appears.

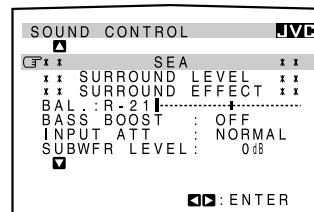

Continued to the next page.

5. Press Δ / ∇ to move $\left[\right]$ to “SURROUND LEVEL,” then press \triangleleft / \triangleright .

The SURROUND LEVEL menu appears.

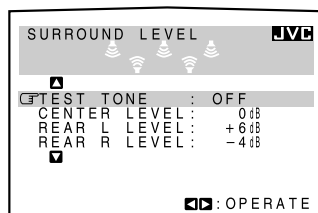

6. Press Δ / ∇ to move $\left[\right]$ to the item you want to set or adjust, then press \triangleleft / \triangleright .

On these adjustment menus, you can do the following:

For Dolby Pro Logic:

- “TEST TONE”: Output a test tone.
- “CENTER LEVEL”: Adjust the center speaker output level. *
- “REAR L LEVEL”: Adjust the left rear speaker output level. **
- “REAR R LEVEL”: Adjust the right rear speaker output level. **

For Dolby Digital and DTS Digital Surround:

- “TEST TONE”: Output a test tone.
- “CENTER LEVEL”: Adjust the center speaker output level. *
- “REAR L LEVEL”: Adjust the left rear speaker output level. **
- “REAR R LEVEL”: Adjust the right rear speaker output level. **

For JVC Theater Surround (Large/small):

- “TEST TONE”: Output a test tone.
- “CENTER LEVEL”: Adjust the center speaker output level. *
- “REAR L LEVEL”: Adjust the left rear speaker output level. **
- “REAR R LEVEL”: Adjust the right rear speaker output level. **

For DAP (LIVE CLUB, DANCE CLUB, CONCERT HALL, CONCERT ARENA):

- “REAR L LEVEL”: Adjust the left rear speaker output level. **
- “REAR R LEVEL”: Adjust the right rear speaker output level. **

Notes:

- * Not displayed when “CENTER SPK” is set to “NONE” (see page 24).
- ** Not displayed when “REAR SPK” is set to “NONE” (see page 24).

7. Press EXIT once.

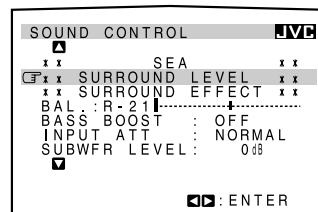

8. Press Δ / ∇ to move $\left[\right]$ to “SURROUND EFFECT,” then press \triangleleft / \triangleright .

The SURROUND EFFECT menu appears.

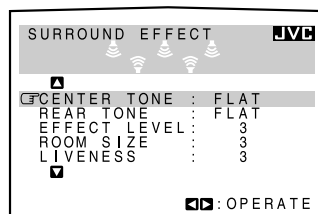

9. Press Δ / ∇ to move $\left[\right]$ to the item you want to set or adjust, then press \triangleleft / \triangleright .

On these adjustment menus, you can do the following:

For Dolby Pro Logic:

- “CENTER TONE”: Select the center tone level. *
- “REAR TONE”: Select the rear tone level. **

For Dolby Digital and DTS Digital Surround:

- “CENTER TONE”: Select the center tone level. *
- “REAR TONE”: Select the rear tone level. **

For JVC Theater Surround (Large/small):

- “CENTER TONE”: Select the center tone level. *
- “REAR TONE”: Select the rear tone level. **
- “EFFECT LEVEL”: Adjust the surround effect level.
- “ROOM SIZE”: Adjust the room size effect.
- “LIVENESS”: Adjust the liveness level.

For DAP (LIVE CLUB, DANCE CLUB, CONCERT HALL, CONCERT ARENA):

- “REAR TONE”: Select the rear tone level. **
- “EFFECT LEVEL”: Adjust the surround effect level.
- “ROOM SIZE”: Adjust the room size effect.
- “LIVENESS”: Adjust the liveness level.

Notes:

- * Not displayed when “CENTER SPK” is set to “NONE” (see page 24).
- ** Not displayed when “REAR SPK” is set to “NONE” (see page 24).

10. When you finish, press EXIT repeatedly until the menu disappears from the TV.

Adjusting the DVD MULTI Playback Mode
(Also see page 41)

1. Press MENU.

The MAIN MENU appears on the TV.

- Pressing one of the Δ / ∇ / \triangleleft / \triangleright buttons also displays the MAIN MENU.

2. Press Δ / ∇ to move $\left[\right]$ to “SOURCE.”

3. Press \triangleleft / \triangleright to select “DVD MULTI.”

4. Press Δ / ∇ to move $\left[\right]$ to “SOUND CONTROL,” then press \triangleleft / \triangleright .

The SOUND CONTROL menu appears.

5. Press Δ / ∇ to move $\left[\right]$ to “SURROUND LEVEL,” then press \triangleleft / \triangleright .

The SURROUND LEVEL menu appears.

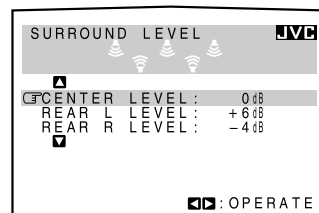

6. Press Δ / ∇ to move $\left[\right]$ to the item you want to set or adjust, then press \triangleleft / \triangleright .

On this adjustment menu, you can do the following:

- “CENTER LEVEL”: Adjust the center speaker output level.
- “REAR L LEVEL”: Adjust the left rear speaker output level.
- “REAR R LEVEL”: Adjust the right rear speaker output level.

7. When you finish, press EXIT repeatedly until the menu disappears from the TV.

■ Selecting Your Favorite SEA Mode

(Also see page 31)

1. Press MENU.

The MAIN MENU appears on the TV.

- Pressing one of the Δ / ∇ / \triangleleft / \triangleright buttons also displays the MAIN MENU.

2. Press Δ / ∇ to move \square to “SOUND CONTROL,” then press \triangleleft / \triangleright .

The SOUND CONTROL menu appears.

3. Press Δ / ∇ to move \square to “SEA,” then press \triangleleft / \triangleright .

The SEA menu appears.

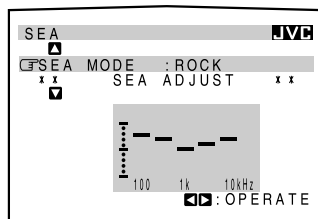

4. Press Δ / ∇ to move \square to “SEA MODE.”

5. Press \triangleleft / \triangleright to select the SEA mode you want.

6. When you finish, press EXIT repeatedly until the menu disappears from the TV.

■ Creating Your Own SEA Mode

(Also see page 31)

1. Press MENU.

The MAIN MENU appears on the TV.

- Pressing one of the Δ / ∇ / \triangleleft / \triangleright buttons also displays the MAIN MENU.

2. Press Δ / ∇ to move \square to “SOUND CONTROL,” then press \triangleleft / \triangleright .

The SOUND CONTROL menu appears.

3. Press Δ / ∇ to move \square to “SEA,” then press \triangleleft / \triangleright .

The SEA menu appears.

4. Press Δ / ∇ to move \square to “SEA ADJUST.”

The SEA ADJUST menu appears.

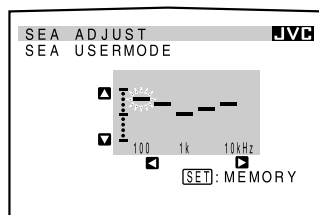

5. Press Δ / ∇ / \triangleleft / \triangleright to adjust the SEA mode as you want.

\triangleleft / \triangleright : Select the frequency ranges.

Δ / ∇ : Adjust the frequency levels.

6. Press SET to store the setting into the SEA USERMODE.

- If you press EXIT, without pressing SET in this step, you can return to the SEA menu. (The adjustment you have made is active but not stored.)

7. When you finish, press EXIT repeatedly until the menu disappears from the TV.

■ Setting the Basic Setting Items (Also see pages 23 – 27)

1. Press MENU.

The MAIN MENU appears on the TV.

- Pressing one of the Δ / ∇ / \triangleleft / \triangleright buttons also displays the MAIN MENU.

2. Press Δ / ∇ to move \square to “SETTING,” then press \triangleleft / \triangleright .

The SETTING 1 or SETTING 2 menu appears.

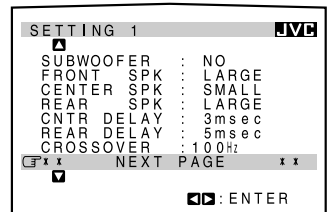

3. Press Δ / ∇ to move \square to the item you want to set or adjust, then press \triangleleft / \triangleright .

- To go to the SETTING 2 menu, move \square to “NEXT PAGE,” then press \triangleleft / \triangleright .
- To go back to the SETTING 1 menu, move \square to “PREVIOUS PAGE,” then press \triangleleft / \triangleright .

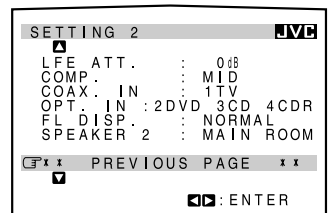

On the SETTING 1 and 2 menus, you can do the following:

- “SUBWOOFER”: Set the subwoofer information (see page 23).
- “FRONT SPK”: Set the front speaker information (see page 24).
- “CENTER SPK”: Set the center speaker information (see page 24).
- “REAR SPK”: Set the rear speaker information (see page 24).
- “CNTR DELAY”: Adjust the delay time of the center speaker output (see page 24). *
- “REAR DELAY”: Adjust the delay time of the rear speaker output (see page 24). **
- “CROSSOVER”: Set the crossover frequency (see page 25).
- “LFE ATT.”: Set the low frequency effect attenuator level (see page 25).
- “COMP.”: Set the dynamic range compression (see page 25).
- “COAX. IN”:
- Set the digital input terminal 1 (see page 26).
- “OPT. IN”:
- Set the digital input terminal 2/3/4 (see page 26).
- “FL DISP.”: Shows the disc text information on the display (see page 27).
- “SPEAKER 2”:
- Select where to use the speakers connected to the FRONT 2/SUB ROOM terminals (see page 23).

Notes:

* Not adjustable when “CENTER SPK” is set to “NONE” (see page 24) or the SUB ROOM speaker (SPEAKERS 2) lamp is lit green (see page 22).

** Not adjustable when “REAR SPK” is set to “NONE” (see page 24) or the SUB ROOM speaker (SPEAKERS 2) lamp is lit green (see page 22).

4. When you finish, press EXIT repeatedly until the menu disappears from the TV.

■ Operating the Tuner (Also see pages 29 and 30)

1. Press MENU.

The MAIN MENU appears on the TV.

- Pressing one of the $\Delta / \nabla / \triangleleft / \triangleright$ buttons also displays the MAIN MENU.

2. Press Δ / ∇ to move \leftarrow to “TUNER CONTROL,” then press $\triangleleft / \triangleright$.

The TUNER CONTROL menu appears.

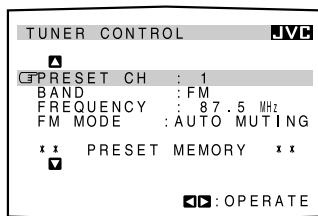

3. Press Δ / ∇ to move \leftarrow to the item you want to set or adjust, then press $\triangleleft / \triangleright$.

On the TUNER CONTROL menu, you can do the following:

- “PRESET CH”: Select a preset channel station.
- “BAND”: Select the band.
- “FREQUENCY”: Tune in a station manually.
- “FM MODE”: Select the FM reception mode.*
- “PRESET MEMORY”: See “Storing the Preset Stations.”

Note:

* Not displayed when an AM station is selected.

4. When you finish, press EXIT repeatedly until the menu disappears from the TV.

■ Storing the Preset Stations (Also see page 29)

1. Press MENU.

The MAIN MENU appears on the TV.

- Pressing one of the $\Delta / \nabla / \triangleleft / \triangleright$ buttons also displays the MAIN MENU.

2. Press Δ / ∇ to move \leftarrow to “TUNER CONTROL,” then press $\triangleleft / \triangleright$.

The TUNER CONTROL menu appears.

3. Tune into a station on the TUNER CONTROL menu, referring to “Operating the Tuner” above.

4. Press Δ / ∇ to move \leftarrow to “PRESET MEMORY,” then press $\triangleleft / \triangleright$.

The PRESET MEMORY menu appears.

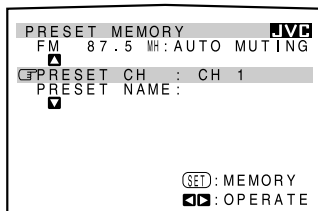

5. Press $\triangleleft / \triangleright$ to select a preset station number you want.

6. Press SET to store the setting.

7. When you finish, press EXIT repeatedly until the menu disappears from the TV.

■ Assigning Names to Preset Stations (Also see page 30)

1. Press MENU.

The MAIN MENU appears on the TV.

- Pressing one of the $\Delta / \nabla / \triangleleft / \triangleright$ buttons also displays the MAIN MENU.

2. Press Δ / ∇ to move \leftarrow to “TUNER CONTROL,” then press $\triangleleft / \triangleright$.

The TUNER CONTROL menu appears.

3. Press Δ / ∇ to move \leftarrow to “PRESET CH.”

4. Press $\triangleleft / \triangleright$ to select a preset station.

5. Press Δ / ∇ to move \leftarrow to “PRESET MEMORY,” then press $\triangleleft / \triangleright$.

The PRESET MEMORY menu appears.

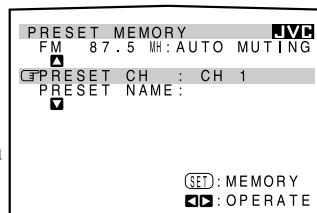

6. Press Δ / ∇ to move \leftarrow to “PRESET NAME,” then press SET.

The character entry screen appears.

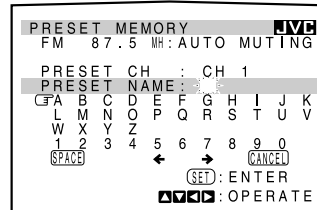

7. Press $\Delta / \nabla / \triangleleft / \triangleright$ to move \leftarrow in front of a character you want.

You can also select the following:

- SPACE : To enter space
- CANCEL : To erase the character
- $\leftarrow \rightarrow$: To go back to the previous character position or go to the next character position

8. Press SET to enter the selected character.

9. Repeat steps 7 and 8 to enter up to four characters.

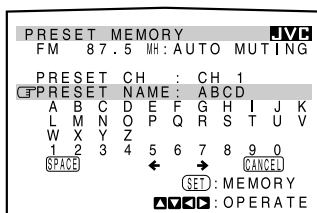

10. Press $\Delta / \nabla / \triangleleft / \triangleright$ to move \leftarrow to “PRESET NAME,” then press SET to store the setting.

The TUNER CONTROL menu appears again.

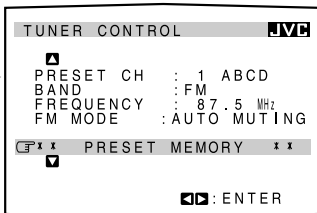

11. When you finish, press EXIT repeatedly until the menu disappears from the TV.

COMPU LINK Remote Control System

The COMPU LINK remote control system allows you to operate JVC audio components through this receiver.

To use this remote control system, you need to connect JVC audio components through the COMPU LINK jacks (see below) in addition to the connections using cables with RCA pin plugs (see pages 6 and 7).

- Make sure that the AC power cords of these components are unplugged before connection. Plug the AC power cords only after all connections are complete.

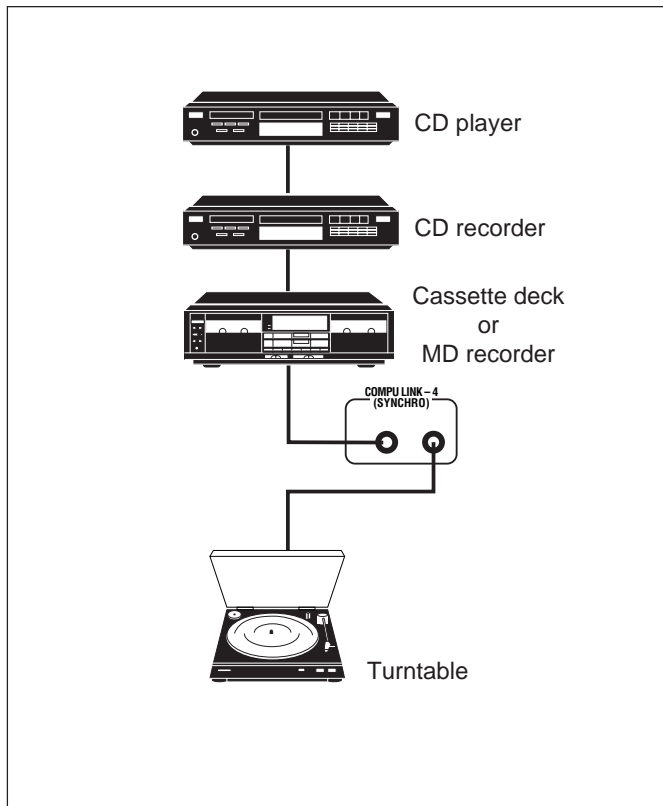

Notes:

- There are four versions of COMPU LINK remote control system. This receiver is equipped with the fourth version — COMPU LINK-4. This version is created by adding systematic operations with the CD recorder to the previous version — COMPU LINK-3.
- If your audio component has two COMPU LINK jacks, you can use either one. If it has only one COMPU LINK jack, connect it so that it is the last item in the series of components. (For example, the turntable or CD player in the diagram above.)
- To operate the cassette deck or MD recorder using the COMPU LINK remote control system, set the source name correctly. (See page 23.)
- Refer also to the manuals supplied with your audio components.

This remote control system allows you to use four functions listed below.

Remote Control through the Remote Sensor on the Receiver

You can control the connected audio components through the receiver using this remote control. For details, see pages 57 and 58.

Automatic Source Selection

- When you press the play (▶) button on a connected component or on its own remote control, the receiver automatically turns on and changes the **main room source** to the component.
 - If the receiver is already turned on and the SUB ROOM CONTROL lamp on the front panel is lit green, the receiver changes the **sub-room source** to the component.
- When you press PLAY on the remote control supplied with this receiver, the receiver automatically turns on and changes the **main room source** or **sub-room source** (depending on the multi-room operation selector setting on the remote control) to the target component.
- When you select a new source on the receiver or on the remote control supplied with this receiver either for **the main room** or **sub-room**, the newly selected component begins playing immediately, and the previously selected source continues playing without sound for a few seconds.

Automatic Power On/Off (Standby): only possible with the COMPU LINK-3 and COMPU LINK-4 connection

Automatic Power On:

- When you turn on the receiver by pressing POWER on the front panel or AUDIO POWER ON on the remote control (with the multi-room operation selector set to “MAIN ROOM”):

OR

When you turn on the main room sound by pressing MAIN ROOM ON/OFF while the receiver is turned on:

- ➔ The MAIN ROOM ON/OFF lamp on the front panel lights red, and one of the connected components will turn on automatically, depending on which component has been previously selected as the **main room source**.

- When you turn on the receiver by pressing AUDIO POWER ON on the remote control (with the multi-room operation selector set to “SUB ROOM”):

OR

When you turn on the sub-room sound by pressing SUB ROOM ON/OFF while the receiver is turned on:

- ➔ The SUB ROOM ON/OFF lamp on the front panel lights green, and one of the connected components will turn on automatically, depending on which component has been previously selected as the **sub-room source**.

Continued to the next page.

Automatic Power Off (Standby):

- **When you turn off the receiver by pressing POWER**, the connected components will turn off (standby).
- **When you turn off the main room sound by pressing MAIN ROOM ON/OFF**, the selected main room source component turns off (unless the same component is selected as the sub-room source).
 - If the SUB ROOM ON/OFF lamp on the front panel is lit green, the main room source will stop playing, but will not turn off.
- **When you turn off the sub-room source by pressing SUB ROOM ON/OFF**, the selected sub-room source component turns off (unless the same component is selected as the main room source).
 - If the MAIN ROOM ON/OFF lamp on the front panel is lit red, the main room source will stop playing, but will not turn off.

Synchronized Recording

This operation is only possible while the receiver is ready for the main room operations.

Synchronized recording means the cassette deck (or MD recorder) starts recording as soon as a CD or a record begins playing.

- When using a CD recorder for synchronized recording, refer to the manual supplied with it.

To use synchronized recording, follow these steps:

- 1. Put a tape in the cassette deck (or an MD in the MD recorder), and a disc in the CD player (or a record on the turntable).**

- 2. Press the record (●) button and the pause (||) button on the cassette deck (or MD recorder) at the same time.**

This puts the cassette deck (or MD recorder) into recording pause.

If you do not press the record (●) button and pause (||) button at the same time, the synchronized recording feature will not operate.

- 3. Press the play (▶) button on the CD player or on the turntable.**

The main room source changes on the receiver, and as soon as play starts, the cassette deck (or MD recorder) starts recording. When the play ends, the cassette deck (or MD recorder) enters recording pause, and stops about 4 seconds later.

Notes:

- *During synchronized recording;*
 - *the selected main room source cannot be changed. (You can change the sub-room source.)*
 - *If the same source is selected both for the main room and the sub-room, operating the sub-room source will affect the recording.*
- *The COMPU LINK remote control system may not operate properly during synchronized recording;*
 - *If the power of any component is shut off during synchronized recording.*
 - *If the main room sound is turned off by pressing MAIN ROOM ON/OFF.*

In this case, you must start again from the beginning.

TEXT COMPU LINK Remote Control System

The TEXT COMPU LINK remote control system has been developed to deal with the disc information recorded in the CD Text* and MDs. Using this information in the discs, you can operate the CD player or MD recorder equipped with the TEXT COMPU LINK remote control system through the receiver.

The following operations are only possible while the receiver is ready for the main room operations, and are used for the main room sources.

CONNECTIONS:

To use this remote control system, you need to connect the CD player and/or MD recorder you want to operate, following the procedures below.

- 1. If you have already plugged your CD player, MD recorder, and this receiver into the AC outlets, unplug their AC power cords first.**
- 2. Connect your CD player, MD recorder, and this receiver as follows, through the COMPU LINK jacks and TEXT COMPU LINK jacks.**

- 1) COMPU LINK jacks:** Use the cables with the monaural mini-plugs (not supplied with this receiver).

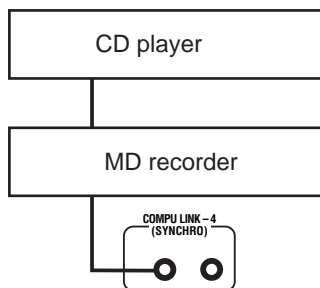

- 2) TEXT COMPU LINK jacks:** Use the cables with the stereo mini-plugs (not supplied with this receiver).

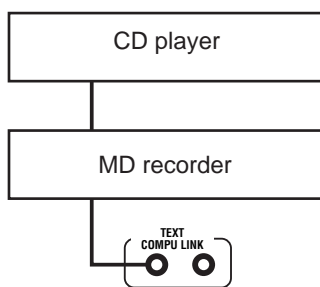

- 3. Connect your CD player, MD recorder and this receiver, using the cables with RCA pin plugs (see pages 6 and 7).**
- 4. Plug the AC power cords of these components above into the AC outlets.**
- 5. When turning on these components for the first time, turn on the connected components first, then turn on this receiver.**

FUNCTIONS:

This remote control system allows you to use the functions listed below.

Displaying the Disc Information on the TV screen

Disc information such as its performer and disc title (and track titles only when a CD Text is selected) is shown on the TV screen.

Disc Search: Only for CD Player

This remote control system can allow you to search for discs by the performer, disc title, and music genre. With this disc search, you can easily find the disc you want to play.

Disc Title Input:

If your CD player or MD recorder has the disc memory function, you can input the following information about the normal audio CDs or MDs on the TV screen.

- For CDs: Performer, disc title, and music genre
- For MDs: Disc title and song titles

****What is a CD Text?***

In a CD Text, some information about the disc (its disc title, performer, composer, arranger, etc.) is recorded.

Notes:

- If your audio component has two COMPU LINK jacks, you can use either one. If it has only one COMPU LINK jack, connect it so that it is the last item in the series of components. (For example, the CD player in the diagram to the left.)
- If your audio component has two TEXT COMPU LINK jacks, you can use either one. If it has only one TEXT COMPU LINK jack, connect it so that it is the last item in the series of components. (For example, the CD player in the diagram to the left.)
- "TEXT COMPULINK SOURCE NOT CONNECTED" appears on the display in the following cases:
 - When the connections explained to the left are not correctly done.
 - When you try to use the TEXT COMPULINK function a few seconds after you turn on the connected equipment. This is not a malfunction of the units.
- Refer also to the manuals supplied with your CD player or MD recorder.

IMPORTANT:

If you turn on the receiver before turning on the other components after connecting the components, the TEXT COMPU LINK remote control system does not work correctly.

If this happens:

- 1. Turn off all the components including this receiver.**
- 2. Turn on the connected components.**
- 3. Turn on this receiver.**

OPERATIONS

To use this remote control system, you need to connect the TV to the MONITOR OUT jack on the rear panel (see page 8), and set the TV's input mode to the proper position to which the receiver is connected. **Make sure you have connected the CD player or MD recorder equipped with the TEXT COMPU LINK remote control system. If not, you cannot use the following functions.**

IMPORTANT:

When using the remote control:

Check to see if the multi-room operation selector and the remote control mode selector are set to the correct position:

• Multi-room operation selector:

To operate this receiver for the main room, set it to "MAIN ROOM."

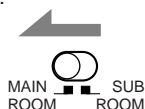

• Remote control mode selector:

To operate this receiver, set it to "AUDIO/TV/VCR."

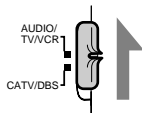

On-Screen Operation buttons (on the remote control)

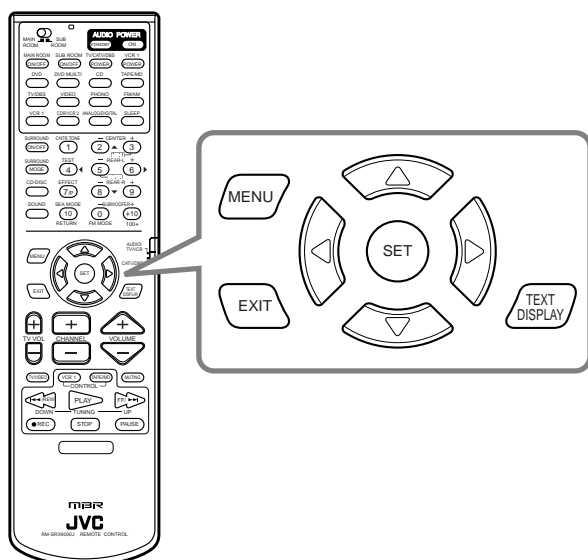

Showing the Disc Information on the TV Screen

Press **TEXT DISPLAY** while "CD" or "MD" is selected as the source.

The Disc Information screen appears on the TV.

Disc Information screen

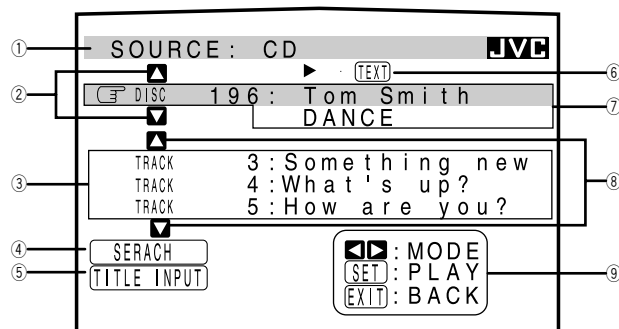

- ① Source name: CD or MD
- ② Select or , then press SET to change the disc.
- ③ Track numbers and track titles.
 - The current playing (selected) track is indicated in yellow.
 - When you move to a track number, you can change the track information by pressing / . Each time you press the button, track information alternates between its track title and its performer. (You can also start playing the track by pressing SET.)

- ④ Select this (move in front), then press SET to go to the DISC SEARCH screen (see page 51).
- ⑤ Select this (move in front), then press SET to go to the TITLE INPUT screen (see page 52).
- ⑥ This appears only when a CD Text is selected.
- ⑦ Disc information such as the disc title, performer, and music genre.

When this is selected (in front), you can change the disc information by pressing / . Each time you press the button, disc information (see "Note on ⑦") changes.

- ⑧ Select or , then press SET to change the track.
- ⑨ Usable buttons and their functions for the current selection.

Indication here will be changed according to what is currently selected (in front) on the screen. See "Note on ⑨."

Note on ⑦:

The following information will appear on the display:

- For CD Texts — Disc title, Performer, Genre, Song writer, Composer, Arranger, Message
Only recorded information will be shown. If there is no data, "NO DATA" will appear.
- For MDs — Disc title
If there is no data, "NO DATA" will appear.

Note on ⑨:

For example, the SET button will be used to start play (PLAY), to go to the next screen (ENTER), and to determine the selection (ENTER).

To exit from the Disc information screen:

Press EXIT.

Notes:

- The on-screen display will disappear in the following cases:
 - if no operation is done for about 10 minutes.
 - if you do any operation other than explained in this section.
- To control the MD recorder using the TEXT COMPU LINK remote control system, you have to change the source name shown on the display from "TAPE" to "MD." (See page 23.)
- Some special characters and marks cannot be displayed correctly.

■ Searching for a Disc (Only for the CD player)

Search for a disc by its performer:

1. Press **TEXT DISPLAY** while “CD” is selected as the source.

The Disc Information screen appears on the TV.

2. Press Δ / ∇ to move \leftarrow to “SEARCH,” then press **SET**.

The DISC SEARCH screen appears.

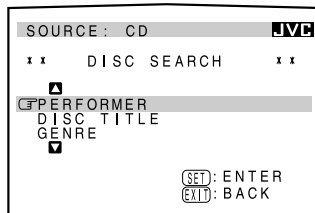

3. Press Δ / ∇ to move \leftarrow to “PERFORMER”, then press **SET**.

The PERFORMER SEARCH screen appears.

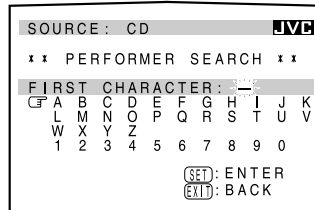

4. Press $\Delta / \nabla / \leftarrow / \rightarrow$ to move \leftarrow in front of the first character of the performer you want to search, then press **SET**.

To correct the incorrect entry, press $\Delta / \nabla / \leftarrow / \rightarrow$ to move \leftarrow in front of the correct character, then press **SET**.

Note:

Symbols such as @, # or \$ cannot be available for search.

5. Press **SET** again.

Disc search starts, then the SEARCH RESULT screen, showing the performers, appears.

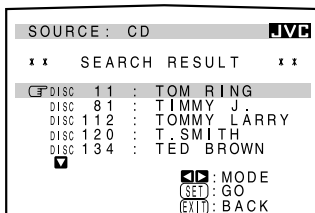

6. On the SEARCH RESULT screen, you can do the following:

- **Changing the indication of the disc information:** Press Δ / ∇ to move \leftarrow to a searched disc, then press \leftarrow / \rightarrow . Each time you press \leftarrow / \rightarrow , the disc information alternates between its performer and its disc title.
- **Starting a disc play and going to the Disc Information screen (see page 50):** Press Δ / ∇ to move \leftarrow to a searched disc, then press **SET**.
- **Showing unseen disc information (if more than 5 discs are listed as a result of the search):** Press Δ / ∇ until they appear.
- **Going back to the PERFORMER SEARCH screen:** Press **EXIT**.

Search for a disc by its disc title:

1. Press **TEXT DISPLAY** while “CD” is selected as the source.

The Disc Information screen appears on the TV.

2. Press Δ / ∇ to move \leftarrow to “SEARCH,” then press **SET**.

The DISC SEARCH screen appears.

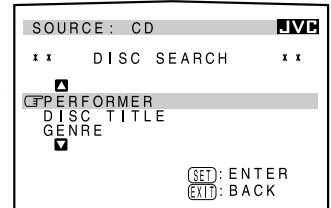

3. Press Δ / ∇ to move \leftarrow to “DISC TITLE,” then press **SET**.

The DISC TITLE SEARCH screen appears.

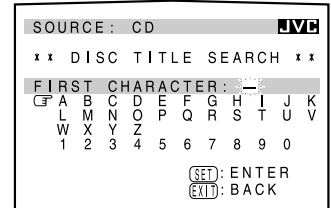

4. Press $\Delta / \nabla / \leftarrow / \rightarrow$ to move \leftarrow in front of the first character of the disc title you want to search for, then press **SET**.

To correct the incorrect entry, press $\Delta / \nabla / \leftarrow / \rightarrow$ to move \leftarrow in front of the correct character, then press **SET**.

Note:

Symbols such as @, # or \$ cannot be available for search.

5. Press **SET** again.

Disc search starts, then the SEARCH RESULT screen, showing the disc titles, appears.

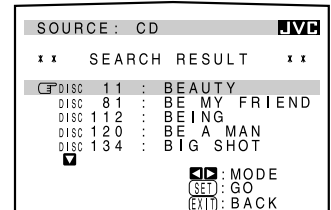

6. On the SEARCH RESULT screen, you can do the following:

- **Changing the indication of the disc information:** Press Δ / ∇ to move \leftarrow to a searched disc, then press \leftarrow / \rightarrow . Each time you press \leftarrow / \rightarrow , the disc information alternates between its disc title and its performer.
- **Starting a disc play and going to the Disc Information screen (see page 50):** Press Δ / ∇ to move \leftarrow to a searched disc, then press **SET**.
- **Showing unseen disc information (if more than 5 discs are listed as a result of the search):** Press Δ / ∇ until they appear.
- **Going back to the DISC TITLE SEARCH screen:** Press **EXIT**.

Search for a disc by its genre:

1. Press **TEXT DISPLAY** while “CD” is selected as the source.

The Disc Information screen appears on the TV.

2. Press Δ / ∇ to move \leftarrow to “SEARCH,” then press **SET**.

The DISC SEARCH screen appears.

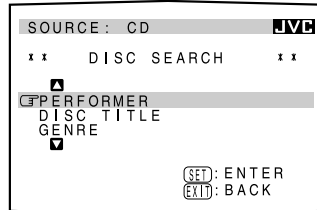

3. Press Δ / ∇ to move \leftarrow to “GENRE,” then press **SET**.

The GENRE SEARCH screen appears.

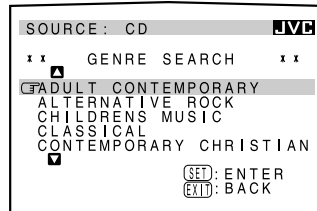

4. Press Δ / ∇ to move \leftarrow to the genre you want to search, then press **SET**.

To show the unseen genres, press Δ / ∇ until they appear.

Disc search starts, then the SEARCH RESULT screen, showing the disc titles, appears.

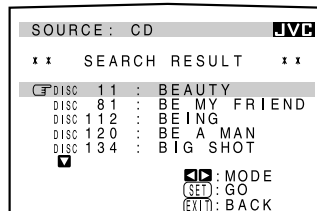

5. On the SEARCH RESULT screen, you can do the following:

- **Changing the indication of the disc information:** Press Δ / ∇ to move \leftarrow to a searched disc, then press $\triangleleft / \triangleright$. Each time you press $\triangleleft / \triangleright$, the disc information alternates between its disc title and its performer.
- **Starting a disc play and going to the Disc Information screen (see page 50):** Press Δ / ∇ to move \leftarrow to a searched disc, then press **SET**.
- **Showing unseen disc information (if more than 5 discs are listed as a result of the search):** Press Δ / ∇ until they appear.
- **Going back to the GENRE SEARCH screen:** Press **EXIT**.

Entering the Disc Information

For the CD Player with the disc memory function:

You can use the disc memory function through this receiver.

The disc information (its performer, disc title, and music genre) of normal audio CDs will be stored into the memory built in the CD player.

For the disc memory function, refer to the manual supplied with your CD player.

- The performer, disc title, and music genre information are usually recorded in a CD Text. However, if a CD Text has no genre information recorded in the disc itself, you can input its music genre by yourself.

Note:

You can enter the TITLE INPUT screens for a CD Text and input its titles. However, you cannot store the titles you have input for a CD Text.

Example: Entering the following information for Disc 1
Performer: “MICHAEL”
Disc title: “MY FAVORITE”

1. Press **TEXT DISPLAY** while “CD” is selected as the source.

The Disc Information screen appears on the TV.

2. Press Δ / ∇ to move \leftarrow to “TITLE INPUT,” then press **SET**.

The TITLE INPUT:
PERFORMER screen appears.

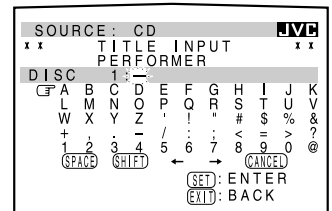

3. Press $\Delta / \nabla / \triangleleft / \triangleright$ to move \leftarrow in front of a character you want, then press **SET** to enter the character.

- If the current CD is a CD Text, go to step 5 without entering the performer.

To use the lower case letters, press $\Delta / \nabla / \triangleleft / \triangleright$ to move \leftarrow to **(SHIFT)**, then press **SET**.

To use the upper case letters again, press $\Delta / \nabla / \triangleleft / \triangleright$ to move \leftarrow to **(SHIFT)**, then press **SET**.

4. Repeat step 3 until you finish putting a performer name (up to 32 characters).

To insert a space, press Δ / ∇ / $\triangleleft / \triangleright$ to move C to SPACE , then press SET.

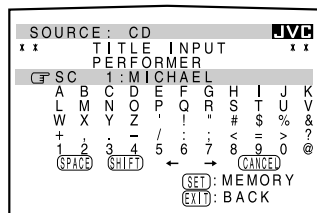

To correct an incorrect character:

- 1) Press Δ / ∇ / $\triangleleft / \triangleright$ to move C to \leftarrow or \rightarrow , then press SET until the incorrect character is selected.
- 2) Press Δ / ∇ / $\triangleleft / \triangleright$ to move C to CANCEL , then press SET to erase the character.
- 3) Press Δ / ∇ / $\triangleleft / \triangleright$ to move C in front of the correct character, then press SET to enter the correct character.

5. Press Δ / ∇ / $\triangleleft / \triangleright$ to move C to "DISC 1: MICHAEL (in this example)," then press SET.

The TITLE INPUT: DISC TITLE screen appears.

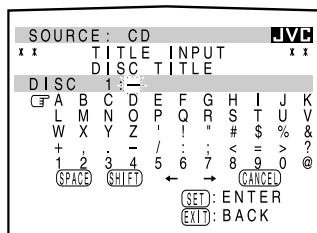

6. Enter the disc title, referring to steps 3 and 4.

• If the current CD is a CD Text, go to the next step without entering the disc title.

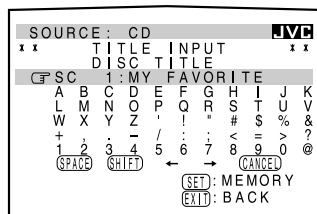

7. Press Δ / ∇ / $\triangleleft / \triangleright$ to move C to "DISC 1: MY FAVORITE (in this example)," then press SET.

The TITLE INPUT: DISC 1 GENRE screen appears.

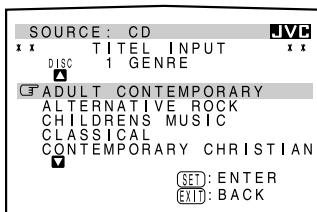

8. Press Δ / ∇ to move C to the genre you want, then press SET.

The Disc Information screen appears again.

To show the unseen genres, press Δ / ∇ until they appear.

For the MD recorder:

You can write the disc information (disc title and song titles) into the disc. You can only write the song title for the song currently selected.

- If you have the CD-MD combination deck, you can also enter the disc information (its performer, disc title, and its music genre) of normal audio CDs into the memory built in the CD-MD combination deck. (To do this, follow the procedure of "For the CD Player with the disc memory function" to the left.)
- If you change the disc or song title including more than 32 characters, the characters following 32nd will be erased from the title.

1. Press TEXT DISPLAY while "MD" is selected as the source.

The Disc Information screen appears on the TV.

2. Press Δ / ∇ to move C to "TITLE INPUT," then press SET.

The DISC TITLE INPUT screen appears.

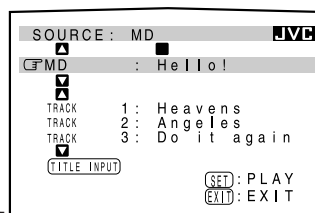

3. Enter the title, referring to steps 3 and 4 of "For the CD Player with the disc memory function" to the left.

• You can enter up to 32 characters for the disc title.

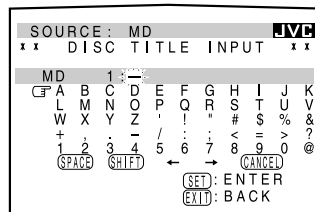

4. Press Δ / ∇ / $\triangleleft / \triangleright$ to move C to the disc title you have just entered, then press SET.

The disc title is stored into the memory, and the SONG TITLE INPUT screen for the currently selected song appears.

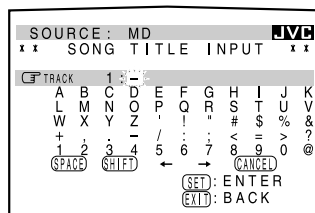

• You can enter a song title for the song currently selected (indicated in yellow on the TV screen).

5. Enter the song title, referring to steps 3 and 4 of "For the CD Player with the disc memory function" to the left.

• You can enter up to 32 characters for the song title.

6. Press Δ / ∇ / $\triangleleft / \triangleright$ to move C to the song title you have just entered, then press SET.

The song title is stored into the memory, and the Disc Information screen appears again.

AV COMPU LINK Remote Control System

The AV COMPU LINK remote control system allows you to operate JVC video components (TV, VCR, and DVD player) through the receiver.

To use this remote control system, you need to connect the video components you want to operate, following the procedure below.

1. If you have already plugged your VCR 1 (VCR connected to the VCR 1 jacks), DVD player, TV, and this receiver into the AC outlets, unplug their AC power cords first.
2. Connect the IR signal transmitter (supplied) to the IR OUT on the rear, and place it so that it is aimed at the remote sensor on the target video components.
 - See "CONNECTIONS 1" below.
3. Connect your VCR 1, DVD player, TV, and this receiver as follows, using the cables with the monaural mini-plugs (not supplied).
 - See "CONNECTIONS 2" below.
4. Connect the audio input/output jacks on VCR 1, DVD player, TV, and this receiver using the cables with RCA pin plug.
 - See pages 7 and 8.
5. Connect the video input/output jacks on VCR 1, DVD player, TV, and this receiver, using the cables with RCA pin plugs or with S-video plugs.
 - See "CONNECTIONS 3" on the next page.
6. Plug the AC power cords of the components into the AC outlets.
7. When turning on the TV for the first time after the AV COMPU LINK connection, turn the TV volume to the minimum using the TV volume control on the TV.
8. Turn on the other connected components first, then turn on this receiver.
 - When turning on the VCR 1, use the remote control supplied with this receiver (press VCR 1 POWER).

CONNECTIONS 1:

On the rear panel

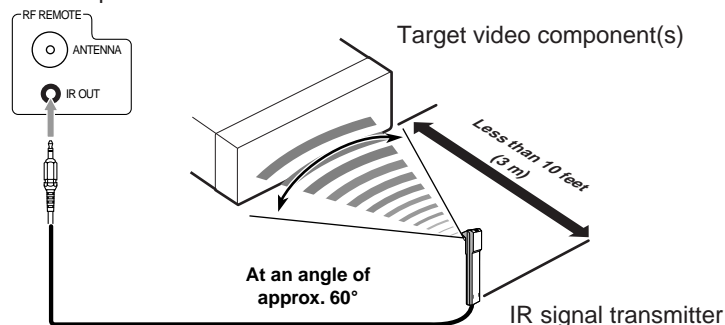

CONNECTIONS 2:

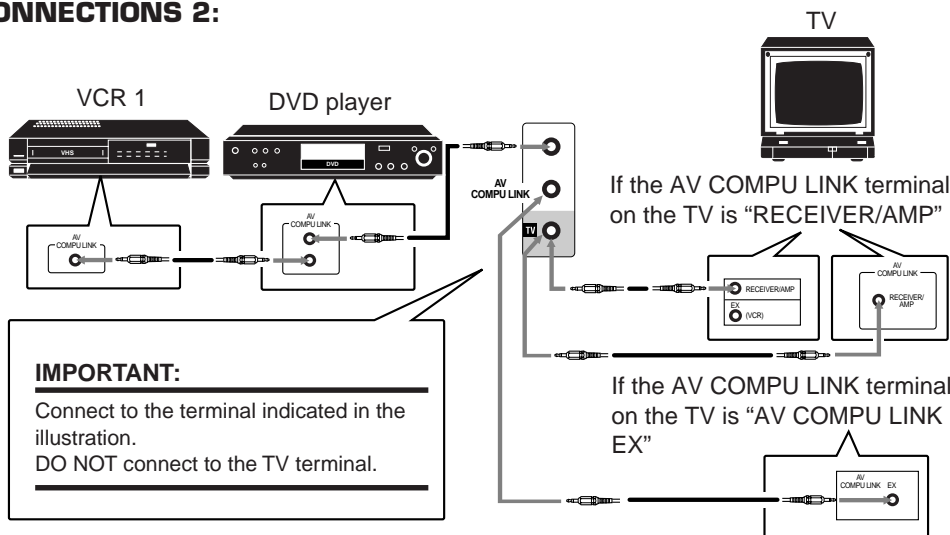

IMPORTANT:

Connect to the terminal indicated in the illustration.
DO NOT connect to the TV terminal.

CAUTION:

The AV COMPU LINK remote control system cannot control the DBS tuner connected to the TV SOUND/DBS jacks, and video components connected to the VIDEO and CDR/VCR 2 jacks on the receiver.

Notes:

- When connecting only the VCR 1 or DVD player to this receiver, connect it directly to the receiver using cable with the monaural mini-plugs.
- Refer also to the manual supplied with your video components.

CONNECTIONS 3:

CASE1: If the components are equipped with the S-video terminals

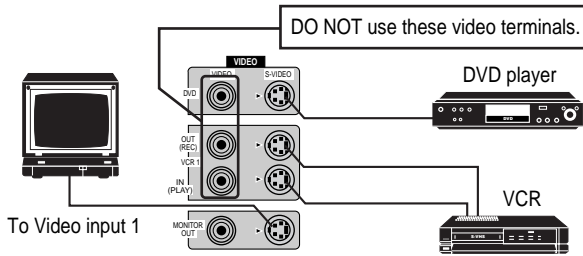

CASE2: If the components are not equipped with the S-video terminals

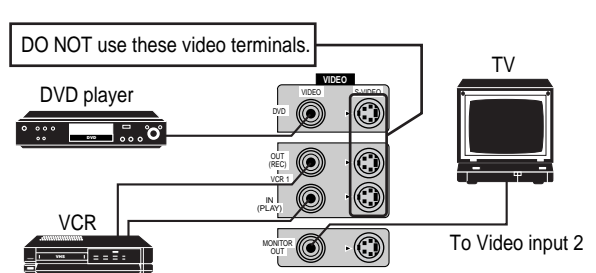

CASE3: If only the VCR is equipped with the S-video terminal

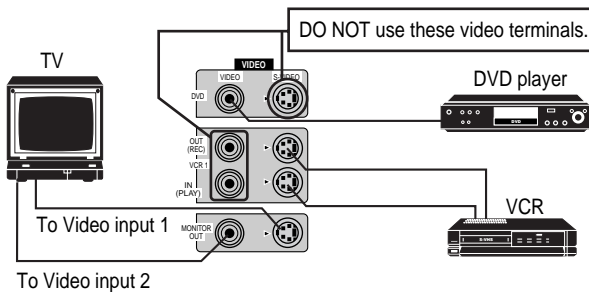

CASE4: If only the DVD player is equipped with the S-video terminal

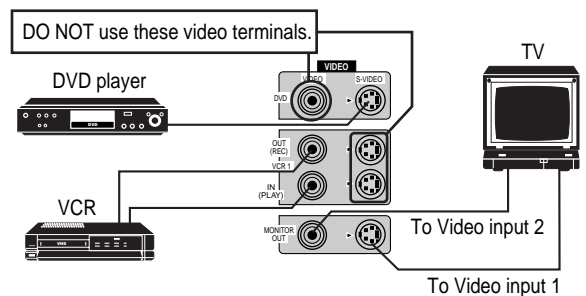

The AV COMPU LINK remote control system allows you to use the five basic functions listed below.

Remote Control of the TV, DVD player, and VCR Using This Remote Control

You can control the connected video components using this remote control, aim the remote control at the remote sensors on the target video component(s) directly.

For details, see page 59.

- For the TV having AV COMPU LINK terminal “RECEIVER/AMP,” aim the remote control directly at the remote sensor on the receiver.)

IMPORTANT:

To operate the video components using the IR signal transmitter (supplied), place it so that it is aimed at the remote sensor on the target video component(s).

- The IR signal transmitter can send signals at a distance of 10 feet (3 m).

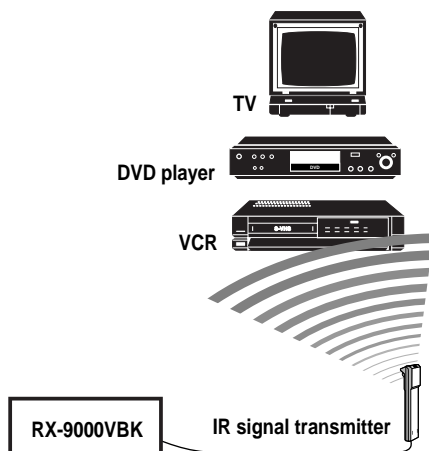

One-Touch Video Play

- Simply by inserting a video cassette without its safety tab into the VCR 1 (the VCR connected to the VCR 1 jacks), you can enjoy the video playback without setting other switches manually. The receiver automatically turns on and changes the **main room source** to “VCR 1.”
The TV automatically turns on and changes the input mode to the position so that you can view the playback picture.
When you insert a video cassette with its safety tab, press the play (▶) button on the VCR 1 or on its remote control. So, you can get the same result.
 - If the receiver is already turned on and the SUB ROOM CONTROL lamp on the front panel is lit green, the receiver changes the **sub-room source** to “VCR 1.” (In this case, the TV will not turn on automatically.)
- When you press PLAY on the remote control supplied with this receiver for operating the VCR 1, the receiver automatically turns on and changes the **main room source** or **sub-room source** (depending on the multi-room operation selector setting on the remote control) to “VCR 1.”
 - For main room operations only: The TV automatically turns on and changes the input mode to the position so that you can view the playback picture.

One-Touch DVD Play

- Simply by starting playback on the DVD player, you can enjoy the DVD playback without setting other switches manually. The TV automatically turns on and changes the input mode to the position — “DVD (or DVD DIGITAL)” or “DVD MULTI” so that you can view the playback picture.
 - If the receiver is already turned on and the SUB ROOM CONTROL lamp on the front panel is lit green, the receiver changes the **sub-room source** to “DVD” (In this case, the TV will not turn on automatically, and no sound comes out if the DVD player is connected only through the digital input terminal on this receiver.)
- When you press PLAY on the remote control supplied with this receiver for operating the DVD player, the receiver automatically turns on and changes the **main room source** or **sub-room source** (depending on the multi-room operation selector setting on the remote control) to the appropriate input — “DVD” (or “DVD DIGITAL”) or “DVD MULTI” as the main room source, and DVD” as the sub-room source.
 - For main room operations only: The TV automatically turns on and changes the input mode to the position so that you can view the playback picture.

Automatic Selection of TV's Input Mode (Only for the Main Room Operations)

- When you select “TV SOUND” (or “TV DIGITAL”) as the **main room source** to play on the receiver, the TV automatically changes the input mode to the TV tuner so that you can watch TV.
- When you select “DVD” (or “DVD DIGITAL”), “DVD MULTI,” “VCR 1,” “CDR/VCR 2,” “VIDEO” or “DBS” (or “DBS DIGITAL”) as the **main room source** to play on the receiver, the TV automatically changes the input mode to the appropriate position (either Video Input 1 or Video Input 2) so that you can view the playback picture.

Note:

When you select “TV SOUND” (or “TV DIGITAL”) as the source on the receiver, you cannot see the menu on the TV screen since the AV COMPU LINK remote control system automatically changes the TV's input mode to the TV tuner.

If you do not mind stopping listening to the TV sounds, you can then show the on-screen displays after changing the TV's input mode to the appropriate position (either Video Input 1 or Video Input 2) the receiver is connected to.

Automatic Power On/Off (Standby)

Automatic Power On:

The TV, VCR 1 (the VCR connected to the VCR 1 jacks), and DVD player turn on and off along with the receiver.

- **When you turn on the receiver by pressing POWER on the front panel or AUDIO POWER ON on the remote control (with the multi-room operation selector set to “MAIN ROOM”):**

OR

When you turn on the main room sound by pressing MAIN ROOM ON/OFF while the receiver is turned on:

The MAIN ROOM ON/OFF lamp lights red, and —

- If the previously selected **main room source** is “VCR 1,” the TV and VCR 1 will turn on automatically.
- If the previously selected **main room source** is “DVD” (or “DVD DIGITAL”) or “DVD MULTI,” the TV and DVD player will turn on automatically.
- If the previously selected **main room source** is “VIDEO,” “CDR/VCR 2,” “TV SOUND” (or “TV DIGITAL”) or “DBS” (or “DBS DIGITAL”), only the TV will turn on automatically.

- **When you turn on the receiver by pressing AUDIO POWER ON on the remote control (with the multi-room operation selector set to “SUB ROOM”):**

OR

When you turn on the sub-room sound by pressing SUB ROOM ON/OFF while the receiver is turned on:

The SUB ROOM ON/OFF lamp lights green, and —

- If the previously selected **sub-room source** is “VCR 1,” the VCR 1 will turn on automatically.
- If the previously selected **sub-room source** is “DVD,” the DVD player will turn on automatically.
- If the previously selected **sub-room source** is “VIDEO,” “CDR/VCR 2,” or “DBS (or DBS DIGITAL),” nothing happens.

Automatic Power Off (Standby):

- **When you turn off the receiver by pressing POWER,** the TV, VCR 1 and the DVD player will turn off (standby).
- **When you turn off the main room sound by pressing MAIN ROOM ON/OFF,** the selected **main room source** component turns off (unless the same component is selected as the sub-room source), and the TV also turns off.
 - If the SUB ROOM ON/OFF lamp on the front panel is lit green, nothing happens.
- **When you turn off the sub-room sound by pressing SUB ROOM ON/OFF,** the selected **sub-room source** component turns off (unless the same component is selected as the main room source).
 - If the MAIN ROOM ON/OFF lamp on the front panel is lit red, nothing happens.

Note:

If you turn off the receiver by pressing POWER or turn off the main room sound by pressing MAIN ROOM ON/OFF while recording on the VCR 1, the VCR 1 will not turn off, but continue recording.

Operating JVC's Audio/Video Components

You can operate JVC's audio components with this receiver's remote control, since control signals for JVC components are preset in the remote control.

IMPORTANT:

To operate JVC's audio components using this remote control:

- You need to connect JVC audio components through the COMPU LINK-3 (SYNCHRO) jacks (see page 47) in addition to the connections using cables with RCA pin plugs (see pages 6 and 7).
- If you use the buttons on the front panel or the menu function to choose a source, the remote control will not operate that source. To operate a source with the remote control, the source must be selected using source selecting buttons on the remote control.
- To operate the cassette deck or MD recorder using the COMPU LINK remote control system, set the source name correctly. (See page 23.)
- Refer also to the manuals supplied with your components.

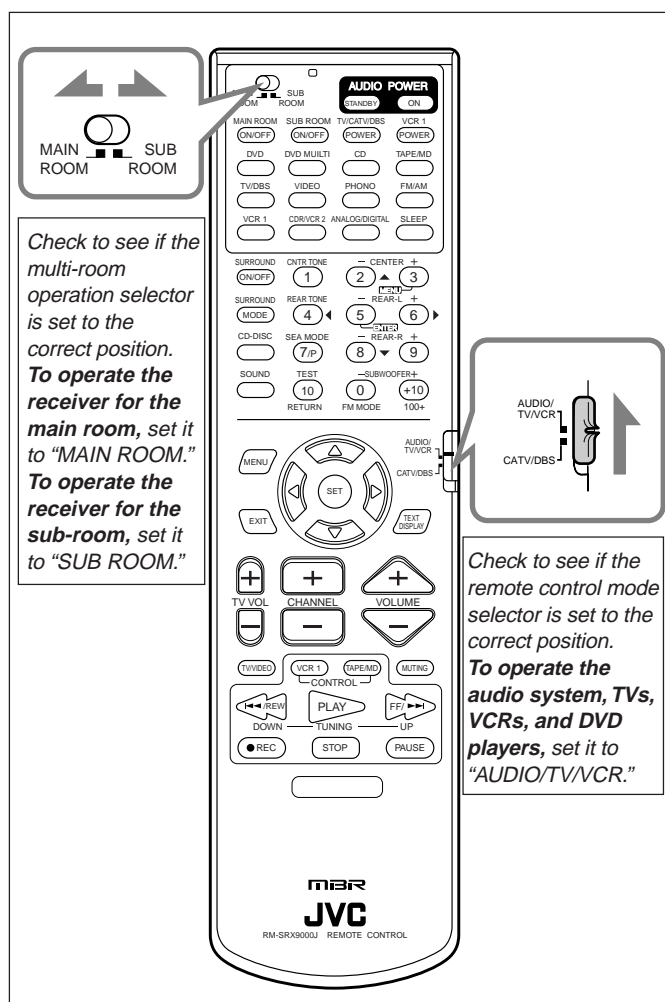

Tuner



You can always perform the following operations (with the remote control mode selector set to "AUDIO/TV/VCR"):

FM/AM: Alternates between FM and AM.

After pressing FM/AM (with the remote control mode selector set to "AUDIO/TV/VCR"), you can perform the following operations:

- 1 - 10, +10:** Selects a preset channel number directly.
 - For channel number 5, press 5.
 - For channel number 15, press +10, then 5.
 - For channel number 20, press +10, then 10.

TUNING UP/TUNING DOWN:

Tunes into stations.

FM MODE: Changes the FM reception mode.

Sound control section (Amplifier)

You can always perform the following operations (with the remote control mode selector set to "AUDIO/TV/VCR"):

SURROUND ON/OFF: Turns on or off the Surround modes — Dolby Pro Logic, Dolby Digital, and DTS Digital Surround.

SURROUND MODE: Selects the DSP modes.

After pressing SOUND (with the remote control mode selector set to "AUDIO/TV/VCR"), you can perform the following operations:

- SEA MODE:** Changes the SEA modes.
- SUBWOOFER - / +:** Adjusts the subwoofer output level.
- CENTER - / +:** Adjusts the center speaker output level.
- REAR•L - / +:** Adjusts the left rear speaker output level.
- REAR•R - / +:** Adjusts the right rear speaker output level.
- CNTR TONE:** Selects the center tone.
- REAR TONE:** Selects the rear tone.
- TEST:** Turns on or off the test tone output.

Note:

After adjusting sounds, press the corresponding source selecting button or CD-DISC to operate your target source by using the 10 keys; otherwise, the 10 keys cannot be used for operating your target source.

CD player



After pressing CD (with the remote control mode selector set to "AUDIO/TV/VCR"), you can perform the following operations on the CD player:

- PLAY:** Starts playing.
- ⏮:** Returns to the beginning of the current (or previous) track.
- ⏭:** Skips to the beginning of the next track.
- STOP:** Stops playing.
- PAUSE:** Pauses playing. To release it, press PLAY.
- 1 - 10, +10:** Selects a track number directly.
 - For track number 5, press 5.
 - For track number 15, press +10, then 5.
 - For track number 20, press +10, then 10.
 - For track number 30, press +10, +10, then 10.

CD player-changer



After pressing CD-DISC (with the remote control mode selector set to “AUDIO/TV/VCR”), you can perform the following operations on a CD player-changer:

PLAY:	Starts playing.
◀◀:	Returns to the beginning of the current (or previous) track.
▶▶:	Skips to the beginning of the next track.
STOP:	Stops playing.
PAUSE:	Pauses playing. To release it, press PLAY.
1 – 6, 7/P:	Selects the number of a disc installed in a CD player-changer.

After pressing CD (with the remote control mode selector set to “AUDIO/TV/VCR”), you can perform the following operations on the CD player-changer:

1 – 10, +10:	Selects a track number directly. For track number 5, press 5. For track number 15, press +10, then 5. For track number 20, press +10, then 10. For track number 30, press +10, +10, then 10.
--------------	--

If your CD changer is of 200-disc loading capability (except for XL-MC100 and XL-MC301)

you can do the following operations using the number buttons after pressing CD.

1. Select a disc number.
2. Then select a track number (always enter two digits).
3. Start playback.

EXAMPLES:

- Selecting disc number 3, track number 2, and starting playback.
Press 3, then, 0, 2, then ▶.
- Selecting disc number 10, track number 5, and starting playback.
Press 1, 0, then, 0, 5, then ▶.
- Selecting disc number 105, track number 12, and starting playback.
Press 1, 0, 5, then 1, 2 then ▶.

CD recorder



After pressing CDR/VCR 2 (with the remote control mode selector set to “AUDIO/TV/VCR”), you can perform the following operations on a CD recorder:

PLAY:	Starts playing.
◀◀:	Returns to the beginning of the current (or previous) track.
▶▶:	Skips to the beginning of the next track.
STOP:	Stops playing.
PAUSE:	Pauses playing. To release it, press PLAY.
1 – 10, +10:	Selects a track number directly. For track number 5, press 5. For track number 15, press +10, then 5. For track number 20, press +10, then 10. For track number 30, press +10, +10, then 10.

Note:

When you start recording on the CD recorder, use the buttons on the CD recorder itself or on the remote control supplied with it.

Turntable



After pressing PHONO (with the remote control mode selector set to “AUDIO/TV/VCR”), you can perform the following operations on a turntable:

PLAY:	Starts playing.
STOP:	Stops operations.

Cassette deck



After pressing TAPE/MD or TAPE/MD CONTROL (with the remote control mode selector set to “AUDIO/TV/VCR”), you can perform the following operations on a cassette deck:

PLAY:	Starts playing.
◀◀:	Fast winds the tape from right to left.
▶▶:	Fast winds the tape from left to right.
STOP:	Stops operations.
PAUSE:	Pauses playing. To release it, press PLAY.
● REC:	Press this button with the PLAY button to start recording. Press this button with the PAUSE button to enter recording pause.

MD recorder



After pressing TAPE/MD or TAPE/MD CONTROL (with the remote control mode selector set to “AUDIO/TV/VCR”), you can perform the following operations on the MD recorder:

PLAY:	Starts playing.
◀◀:	Returns to the beginning of the current (or previous) track.
▶▶:	Skips to the beginning of the next track.
STOP:	Stops playing.
PAUSE:	Pauses playing. To release it, press PLAY.
● REC:	Press this button with the PLAY button to start recording. Press this button with the PAUSE button to enter recording pause.

Note:

You can use either TAPE/MD button or the TAPE/MD CONTROL button to activate the buttons listed above. If you press TAPE/MD, the playing source also changes. On the other hand, if you press TAPE/MD CONTROL, the playing source does not change.

IMPORTANT:

- To operate JVC's video components using this remote control:
- You need to connect JVC video components through the AV COMPU LINK terminals (see page 54) in addition to the connections using cables with RCA pin plugs (see pages 7 and 8).
 - Some JVC VCRs can accept two types of the control signals — remote codes "A" and "B." Before using this remote control, make sure that the remote control code of the VCR connected to the VCR 1 jacks is set to code "A."
 - When another JVC VCR is connected to the CDR/VCR 2 jacks, set its remote control code to code "B." (This remote control cannot emit the control signals of code "B.")
 - To operate the video components only using this remote control, aim the remote control at the remote sensors on the target video component(s) directly. **(For the TV having AV COMPU LINK terminal "RECEIVER/AMP," aim the remote control directly at the remote sensor on the receiver.)**
 - To operate the video component(s) using the RF signals emitted from this remote control, the IR signal transmitter and the RF rod antenna must be connected to this receiver.
 - Place the IR signal transmitter so that it is aimed at the remote sensor on the target video component(s).
 - The RF signal-reachable distance may differ depending on the operating conditions and circumstances.
 - The IR signal transmitter can send signals at a distance of 10 feet (3 m).

VCR 1 (VCR connected to the VCR 1 jacks)



You can always perform the following operations (with the remote control mode selector set to "AUDIO/TV/VCR"):

- VCR 1 POWER:** Turns on or off the VCR 1.
- After pressing VCR 1 or VCR 1 CONTROL (with the remote control mode selector set to "AUDIO/TV/VCR"), you can perform the following operations on the VCR 1:
- 1 – 9, 0:** Selects the TV channels on VCR 1.
 - PLAY:** Starts playing.
 - REW:** Rewinds a tape.
 - FF:** Fast winds a tape.
 - STOP:** Stops operations.
 - PAUSE:** Pauses playing. To release it, press PLAY.
 - REC:** Press this button with the PLAY button to start recording. (Only for the main room operations) Press this button with the PAUSE button to enter recording pause.
 - CHANNEL +/-:** Changes the TV channels on the VCR.

Note:

You can use either VCR 1 button or the VCR 1 CONTROL button to activate the buttons listed above. If you press VCR 1, the playing source also changes. On the other hand, if you press VCR 1 CONTROL, the playing source does not change.

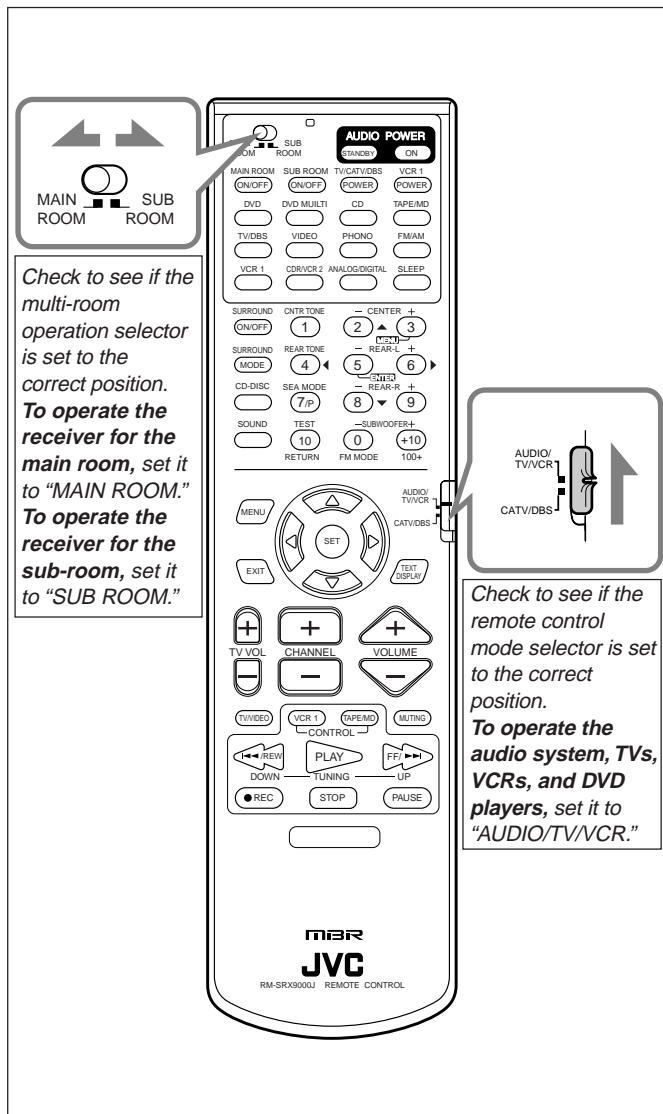

DVD player



After pressing DVD (or DVD MULTI: only for the main room operations) (with the remote control mode selector set to "AUDIO/TV/VCR"), you can perform the following operations on a DVD player:

- PLAY:** Starts playing.
- ◀◀:** Returns to the beginning of the current (or previous) track.
- ▶▶:** Skips to the beginning of the next track.
- STOP:** Stops playing.
- PAUSE:** Stops playing temporarily. To release it, press PLAY.

After pressing DVD (or DVD MULTI: only for the main room operations), these buttons can be used for the DVD menu operations.

Note: For detailed menu operations, refer to the instructions supplied with the discs or the DVD player.

TV

You can always perform the following operations only for the main room operations (with the remote control mode selector set to "AUDIO/TV/VCR"):

- TV/CATV/DBS POWER:** Turns on or off the TV.
- TV VOL +/-:** Adjusts the volume.
- TV/VIDEO:** Sets the input mode (either TV or VIDEO).

After pressing TV/DBS (with the remote control mode selector set to "AUDIO/TV/VCR"), you can perform the following operations on a TV:

- CHANNEL +/-:** Changes the channels.
- 1 – 9, 0, 100+:** Selects the channels.
- RETURN:** Alternates between the previously selected channel and the current channel.

Operating Other Manufacturers' Video Equipment

This remote control supplied with the receiver can transmit control signals for other manufacturers' VCRs, TVs, CATV converters, DBS tuners, and DVD players. By changing the transmittable signals from preset ones to the other manufacturers', you can operate the other manufacturer's components using this remote control.

When operating the other manufacturers' components, refer also to the manuals supplied with them. To operate these components with the remote control, first you need to set the manufacturer's code each for VCR, TV, CATV converter, DBS tuner, and DVD player.

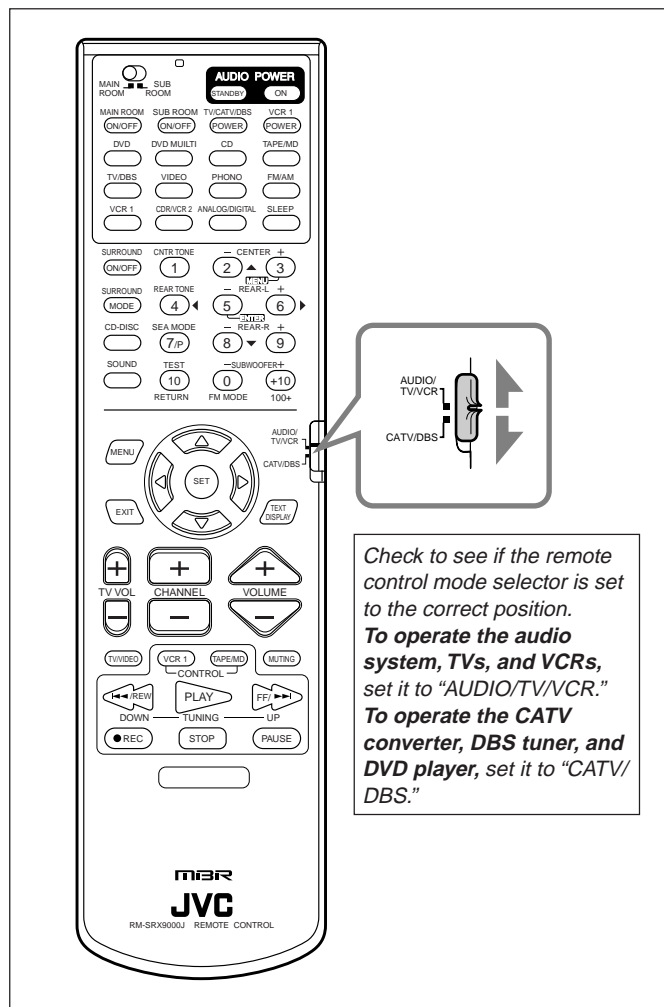

To change the transmittable signals for operating another manufacturer's TV

1. Set the remote control mode to "AUDIO/TV/VCR."
2. Press and hold TV/CATV/DBS POWER.
3. Press TV/DBS.
4. Enter manufacturer's code (two digits) using buttons 1–9, and 0.

See the list on page 62 to find the code.

Examples: For a JVC product, press 2, 8.
For a Sanyo product, press 2, 5.

5. Release TV/CATV/DBS POWER.

The following buttons can be used for operating the TV (with the remote control mode selector set to "AUDIO/TV/VCR"):

TV POWER	Turns on and off the TV.
TV VOL +/-	Adjusts the volume.
TV/VIDEO	Sets the input mode (either TV or VIDEO).

After pressing TV/DBS (with the remote control mode selector set to "AUDIO/TV/VCR"), you can perform the following operations on a TV:

CHANNEL +/-	Changes the channels.
1 – 10, 0, 100+ (+10)	Selects the channels.
	The 100+ (+10) button will function as the ENTER button if your TV requires pressing ENTER after selecting a channel number.

6. Try to operate your TV by pressing TV/CATV/DBS POWER.

When your TV turns on or off, you have entered the correct code.

If there are more than one code listed for your brand of TV, try each one until the correct one is entered.

To change the transmittable signals for operating a CATV converter or DBS tuner

1. Set the remote control mode to "CATV/DBS."
2. Press and hold TV/CATV/DBS POWER.
3. Press TV/DBS.
4. Enter manufacturer's code (two digits) using buttons 1 – 9, and 0.

See the list on page 62 to find the code.

Examples: For a JVC product, press 5, 7.
For a Sony product, press 6, 5.

IMPORTANT:

- To operate the video component(s) using the RF signals emitted from this remote control, the IR signal transmitter and the RF rod antenna must be connected to this receiver.
 - Place the IR signal transmitter so that it is aimed at the remote sensor on the target video component(s).
 - The RF signal-reachable distance may differ depending on the operating conditions and circumstances.
 - The IR signal transmitter can send signals at a distance of 10 feet (3 m).

5. Release TV/CATV/DBS POWER.

After setting the remote control mode selector to "CATV/DBS," you can perform the following operations on the CATV convertor or on the DBS tuner:

TV/CATV/DBS POWER: Turns on and off the CATV converter or DBS tuner.



CHANNEL +/-: Changes the channels.

1 – 10, 0, 100+ (+10): Selects the channel.
100+ (+10) button will function as the ENTER button if your equipment requires pressing ENTER after selecting a channel number.

6. Try to operate your CATV converter or DBS tuner by pressing TV/CATV/DBS POWER.

When your CATV converter or DBS tuner turns on or off, you have entered the correct code.

If there are more than one code listed for your brand of CATV converter or DBS tuner, try each one until the correct one is entered.

To change the transmittable signals for operating another manufacturer's VCR

1. Set the remote control mode to "AUDIO/TV/VCR."

2. Press and hold VCR 1 POWER.

3. Press VCR 1.

4. Enter manufacturer's code (two digits) using buttons 1–9, and 0.

See the list on page 62 to find the code.

Examples: For a JVC product, press 1, 7.
For an NEC product, press 3, 9.

5. Release VCR 1 POWER.

The following button can be used for operating the VCR (with the remote control mode selector set to "AUDIO/TV/VCR"):

VCR 1 POWER Turns on and off the VCR.



After pressing VCR 1 or VCR 1 CONTROL (with the remote control mode selector set to "AUDIO/TV/VCR"), you can perform the following operations on the VCR 1:

CHANNEL +/- Changes the TV channels on the VCR.
1 – 10, 0, 100+ (+10) Selects the TV channels on the VCR.
The 100+ (+10) button will function as the ENTER button if your VCR requires pressing ENTER after selecting a channel number.

PLAY Starts playback.
◀◀ Rewinds a video tape.
▶▶ Fast winds a video tape.
STOP Stops operation.
PAUSE Pauses.
● REC: Starts recording or enters recording pause.

Note:

You can use either VCR 1 button or the VCR 1 CONTROL button to activate the buttons listed above. If you press VCR 1, the playing source also changes. On the other hand, if you press VCR 1 CONTROL, the playing source does not change.

6. Try to operate your VCR by pressing VCR 1 POWER.

When your VCR turns on or off, you have entered the correct code.

If there are more than one code listed for your brand of VCR, try each one until the correct one is entered.

To change the transmittable signals for operating a DVD player

1. Set the remote control mode to "AUDIO/TV/VCR."

2. Press and hold VCR 1 POWER.

3. Press DVD.

4. Enter manufacturer's code (two digits) using buttons 1–9, and 0.

See the list on page 62 to find the code.

Examples: For a JVC product, press 0, 1.
For a Sony product, press 0, 5.

5. Release VCR 1 POWER.

After pressing DVD (or DVD MULTI: only for the main room operations) (with the remote control mode selector set to "AUDIO/TV/VCR"), you can perform the following operations on a DVD player:

PLAY: Starts playing.
◀◀: Returns to the beginning of the current (or previous) track.
▶▶: Skips to the beginning of the next track.
STOP: Stops playing.
PAUSE: Stops playing temporarily. To release it, press PLAY.



After pressing DVD (or DVD MULTI: only for the main room operations), these buttons can be used for the DVD menu operations.

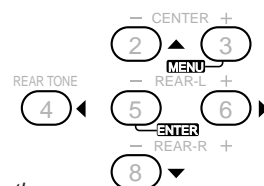

Note:

For detailed menu operations, refer to the instructions supplied with the discs or the DVD player.

6. Try to operate your DVD player by pressing one of the above buttons.

- DO NOT forget to turn on the DVD player before pressing one of the above buttons.

Manufacturers' codes for the TV

Aiwa	52, 53
Akai	03
Bell & Howell	38
Centurion	12
Coronad	13
Daewoo	35, 36, 41
Emerson	20, 21, 22, 23, 42
Fisher	25
Fujitsu	54, 55
Funai	56, 57, 58, 59
GE	02, 18, 49
GoldStar	30, 46
Hitachi	31, 32
JVC	28, 29, 60, 61
KTV	33, 34
LXI	11, 44, 56
Magnavox	11, 43, 47, 62
Marantz	24
Matsushita	16, 17, 18, 49, 64, 65
Mitsubishi	24
NEC	63
Panasonic	16, 17, 18, 49, 64, 65
Philips	11
Pioneer	37, 66
Proscan	44
Quasar	48
Radio Shack	15
RCA	02, 04, 05, 06, 07, 08, 45, 67
Samsung	26, 27, 68
Sanyo	25, 69, 70, 71
Sears	19
Sharp	14, 72
Sony	01, 73
Symphonic	39, 40
Toshiba	19
Zenith	09, 10, 74

Manufacturers' codes for the CATV converter

Gemini	33
General Instrument	18
Hamlin	23, 24, 25, 26, 42, 43, 44, 45
Jerold	01, 02, 03, 04, 05, 06, 07, 08, 22, 46, 47, 48, 49, 50, 51, 52, 53
Macom	30, 31, 32
Magnavox	34
Oak	27, 28, 29
Panasonic	19, 20, 21
Philips	36, 37, 38, 39, 40, 41
Pioneer	14, 15, 54
Samsung	35
Scientific Atlanta	09, 10, 11, 55
Tocom	16, 17
Zenith	12, 13, 56

Manufacturers' codes for the DBS tuner

Echostar	57
Expressvu	57
General Instrument	58
Hitachi	59
HTS	57
Hughes Network Systems	60
JVC	57
Panasonic	61
Primestar	62
RCA	63, 64
Sony	65
Toshiba	66

Manufacturers' codes for the VCR

Aiwa	35, 50, 58, 59, 60
Akai	52, 53, 54
Bell & Howell	46
Daewoo	44
Emerson	19, 20, 21, 22, 23, 63
Fisher	33, 36, 37, 38
Funai	61, 62, 63, 64
GE	07, 32
Go Video	42, 43, 51
GoldStar	35
Hitachi	07, 08, 65
JVC	17, 47, 48, 49, 66
Magnavox	11, 12, 13
Matsushita	09, 10, 71, 72, 73
Mitsubishi	26, 27, 28, 29, 56, 57, 67
NEC	39, 40, 68, 69, 70
Orion	55
Panasonic	09, 10, 71, 72, 73
Philips	13
Pioneer	74
RCA	08, 32, 75
Samsung	16, 24, 25
Sanyo	76, 77, 78
Scott	15
Sharp	30, 31, 79
Shintom	18
Sony	01, 02, 03, 04, 05, 06
Symphonic	41
Teknika	41, 45
Toshiba	14, 15, 80
Zenith	34, 81

Manufacturers' codes for the DVD player

JVC	01
Panasonic	02
Philips	04
Pioneer	03
Sony	05
Toshiba	06
Yamaha	07

Manufacturers' codes are subject to change without notice. If they are changed, this remote control cannot operate the equipment.

Troubleshooting

Use this chart to help you solve daily operational problems. If there is any problem you cannot solve, contact your JVC service center.

PROBLEM	POSSIBLE CAUSE	SOLUTION
The display does not light up.	The power cord is not plugged in.	Plug the power cord into an AC outlet.
The buttons and controls on the front panel do not work.	The Multi-room function is not set correctly.	<ul style="list-style-type: none"> • Press MAIN ROOM ON/OFF for the main room operations. • Press SUB ROOM ON/OFF and SUB ROOM CONTROL for the sub-room operations.
No sound from the speakers in the main room.	Speaker signal cables are not connected properly.	Check speaker wiring and reconnect if necessary.
	The SPEAKERS 1 (MAIN ROOM) and SPEAKERS 2 (SUB ROOM) buttons are not set correctly.	Press SPEAKERS 1 (MAIN ROOM) and SPEAKERS 2 (SUB ROOM) correctly.
	An incorrect source is selected for the main room.	Select the correct main room source.
	Muting is activated for the main room source.	Press MUTING to cancel the mute.
No sound from the front speakers in the sub-room.	Speaker signal cables are not connected properly.	Check speaker connection and reconnect if necessary. (See page 11.)
	Main/sub setting for the speakers connected to the FRONT 2/SUB ROOM terminals are not set correctly.	Set the main/sub setting for the speakers correctly to use them as the sub-room front speakers. (See page 23.)
	Amplifier connected to the SUB ROOM PRE OUT is not turned on.	Turn on the amplifier.
	An incorrect source is selected for the sub-room.	Select the correct sub-room source.
	Muting is activated for the sub-room source.	Press MUTING to cancel the mute.
Sound from one speaker only in the main room.	The balance is set to one extreme.	Adjust the balance properly (see page 19).
The SUB ROOM ON/OFF button does not work.	Surround is used for the main room.	Cancel the Surround in the main room.
Surround cannot be used for the main room sources.	Sub-room sound is activated (the SUB ROOM ON/OFF lamp and SUB ROOM speaker (SPEAKERS 2) lamp on the front panel is lit green).	Deactivating the sub-room sound will allow you to use the Surround in the main room.
CD tracks are skipped, tape is rewound, or radio station is changed unintentionally.	When the same source is selected both for the main room and the sub-room, the source is operated in one room, and therefore, affecting the source in the other room.	This is normal, not the malfunction of the unit. Selecting different sources for the main room and the sub-room will avoid these troubles.
The receiver does not work correctly as you operate it.	Main room and sub-room operations are done at the same time.	If this happens, perform the same operation again.

Continued to the next page.

PROBLEM	POSSIBLE CAUSE	SOLUTION
Continuous hiss or buzzing during FM reception.	Incoming signal is too weak.	Connect an outdoor FM antenna or contact your dealer.
	The station is too far away.	Select a new station.
	An incorrect antenna is used.	Check with your dealer to be sure you have the correct antenna.
Occasional cracking noise during FM reception.	Antennas are not connected properly. Ignition noise from automobiles.	Check connections. Move the antenna farther from automobile traffic.
No colors on the on-screen display.	The color system of the connected TV is not NTSC.	Connect an NTSC TV.
Howling during record playing.	Your turntable is too close to speakers.	Move speakers away from the turntable.
"OVERLOAD" starts flashing on the display.	Speakers are overloaded because of high volume either in the main room or in the sub-room.	<ol style="list-style-type: none"> 1. Press POWER on the front panel to turn off the receiver. 2. Stop the playback source. 3. Turn on the receiver again, and adjust the volume.
	Speakers are overloaded because of short circuit of speaker terminals.	Press POWER on the front panel to turn off the receiver, check the speaker wiring, then press it again to turn on the receiver again. If "OVERLOAD" does not disappear though speaker wiring is not short-circuited, consult your dealer.
"TURN ON MAIN OR SUB ROOM" appears on the display.	The receiver is turned on with the main room and sub-room sounds deactivated.	<ul style="list-style-type: none"> • Press MAIN ROOM ON/OFF for the main room operations. • Press SUB ROOM ON/OFF for the sub-room operations.
Remote control does not work.	The multi-room operation selector is not set correctly.	Set the selector correctly either to "MAIN ROOM" or to "SUB ROOM."
	The remote control mode selector is not set correctly.	Set the selector correctly either to "AUDIO/TV/VCR" or to "CATV/DBS."
	RF communication between the receiver and the remote control is interrupted from outside.	Consult your dealer.
	Batteries are weak.	Replace batteries.

Specifications

Amplifier

Output Power

At Stereo operation:

Front channels: **120 W per channel, min. RMS, driven into 8 Ω, 20 Hz to 20 kHz with no more than 0.02% total harmonic distortion.**

120 W per channel, min. RMS, driven into 4 Ω, 20 Hz to 20 kHz with no more than 0.08% total harmonic distortion.

At Surround operation:

Front channels: 100 W per channel, min. RMS, driven into 8 Ω at 1 kHz with no more than 0.8% total harmonic distortion.

Center channel: 100 W, min. RMS, driven into 8 Ω at 1 kHz, with no more than 0.8% total harmonic distortion.

Rear channels: 100 W per channel, min. RMS, driven into 8 Ω at 1 kHz, with no more than 0.8% total harmonic distortion.

Audio

Audio Input Sensitivity/Impedance (1 kHz):

PHONO (MM): 2.5 mV/47 kΩ

CD, TAPE/MD, TV SOUND/DBS, VCR 1, CDR/VCR 2, VIDEO, DVD: 200 mV/47 kΩ

Audio Input (DIGITAL IN)* :

Coaxial: DIGITAL 1 (DVD): 0.5 V(p-p)/75 Ω

Optical: DIGITAL 2 (CD), DIGITAL 3 (TV), DIGITAL 4 (CDR): -21 dBm to -15 dBm (660 nm ±30 nm)

* Corresponding to Linear PCM, Dolby Digital, and DTS Digital Surround (with sampling frequency — 32 kHz, 44.1 kHz, 48 kHz).

Audio Output Level:

SUB ROOM PRE OUT: 200 mV

Recording Output Level: TAPE/MD, VCR 1, CDR/VCR 2: 200 mV

Digital output: Optical: DIGITAL OUTPUT

Signal wave length: 660 nm

Output level: -21 dBm to -15 dBm

Signal-to-Noise Ratio (*66 IHF/78 IHF):

PHONO: 70 dB/78 dB (at REC OUT)

CD, TAPE/MD, TV SOUND/DBS, VCR 1, CDR/VCR 2, VIDEO, DVD: 92 dB/80 dB

Frequency Response (8 Ω):

PHONO: 20 Hz to 20 kHz (±1 dB)

CD, TAPE/MD, TV SOUND/DBS, VCR 1, CDR/VCR 2, VIDEO, DVD: 20 Hz to 20 kHz (±1 dB)

DVD MULTI: 20 Hz to 100 kHz (+1 dB, -3 dB)

RIAA Phono Equalization: ±1.0 dB (20 Hz to 20 kHz)

Bass boost (Volume control at -30 dB):

+6 ±1.0 dB at 100 Hz

SEA: Center frequencies: 100 Hz, 1 kHz, 10 kHz

Control range: ±10 dB ±1 dB

Video

Video Input Sensitivity/Impedance:

Composite video: TV SOUND/DBS, VCR 1, CDR/VCR 2, VIDEO, DVD: 1 V(p-p)/75 Ω

S-video: TV SOUND/DBS, VCR 1, VIDEO, DVD:

(Y: luminance): 1 V(p-p)/75 Ω

(C: chrominance, burst): 0.286 V(p-p)/75 Ω

Video Output Level:

Composite video: VCR 1, CDR/VCR 2, MONITOR OUT:

1 V(p-p)/75 Ω

S-video: VCR 1, MONITOR OUT:

(Y: luminance): 1 V(p-p)/75 Ω

(C: chrominance, burst): 0.286 V(p-p)/75 Ω

Synchronization: Negative

Signal-to-Noise Ratio: 45 dB

On-Screen Color System: NTSC

FM tuner (IHF)

Tuning Range: 87.5 MHz to 108.0 MHz

Usable Sensitivity: Monaural: 12.8 dBf (1.2 μV/75 Ω)

50 dB Quieting Sensitivity:

Monaural: 21.3 dBf (3.2 μV/75 Ω)

Stereo: 41.3 dBf (31.5 μV/75 Ω)

Signal-to-Noise Ratio (IHF-A weighted):

Monaural: 78 dB at 85 dBf

Stereo: 73 dB at 85 dBf

Total Harmonic Distortion:

Monaural: 0.4% at 1 kHz

Stereo: 0.6% at 1 kHz

Stereo Separation at REC OUT: 35 dB at 1 kHz

Alternate Channel Selectivity: 45 dB: (±400 kHz)

Frequency Response: 30 Hz to 15 kHz: (+0.5 dB, -3 dB)

AM tuner

Tuning Range: 530 kHz to 1,710 kHz

Usable Sensitivity: Loop antenna: 400 μV/m

Signal-to-Noise Ratio: 50 dB (100 mV/m)

General

Power Requirements: AC 120V[~], 60 Hz

Power Consumption: 320 W/420 VA (at operation)
2 watts (in standby mode)

Dimensions (W x H x D): 435 mm x 157 mm x 412.5 mm
(17 ³/₁₆ in. x 6 ³/₁₆ in. x 16 ¹/₄ in.)

Mass: 11.9 kg (26.3 lbs)

HOW TO LOCATE YOUR JVC SERVICE CENTER

TOLL FREE : 1-800-537-5722

<http://www.jvcservice.com>

Dear customer:

In order to receive the most satisfaction from your purchase, read the instruction booklet before operating the unit. In the event that repair is necessary, or for the address nearest your location, please refer to the factory service center list below or within the Continental United States, Call 1-800-537-5722 for your authorized servicer. Remember to retain your Bill of Sale for Warranty Service.

—JVC

JVC SERVICE & ENGINEERING COMPANY OF AMERICA

DIVISION OF JVC AMERICAS CORP.

FACTORY SERVICE CENTER LOCATIONS

10 New Maple Avenue
Pine Brook, NJ 07058-9641
(973) 396-1000

1500 Lakes Parkway
Lawrenceville, GA 30243-5857
(770) 339-2582

705 Enterprise Street
Aurora, IL 60504-8149
(630) 851-7855

5665 Corporate Avenue
Cypress, CA 90630-0024
(714) 229-8011

2969 Mapunapuna Place
Honolulu, HI 96819-2040
(808) 833-5828

10700 Hammerly, Suite 110
Houston, TX 77043
(713) 935-9331

13 Cummings Park
Woburn, MA 01801
(781) 376-9100

8192 State Road 84
Davie, FL 33324
(954) 472-1960

890 Dubuque Avenue
South San Francisco, CA 94080-1804
(650) 871-2666

Sophisticated electronic products may require occasional service. Just as quality is a keyword in the engineering and production of the wide array of JVC products, service is the key to maintaining the high level of performance for which JVC is world famous. The JVC service and engineering organization stands behind our products.

NATIONAL HEADQUARTERS
JVC SERVICE & ENGINEERING COMPANY OF AMERICA
DIVISION OF JVC AMERICAS CORP.

1700 Valley Road
Wayne, NJ 07470

If you ship the product •••

Pack your JVC unit in the original carton or one of equivalent size and strength. Enclose, with the unit, a letter stating the problem or symptom that exists and also a copy of the receipt or bill of sale you received when you purchased your JVC unit. Print your home return address on the outside and the inside of the carton. Send to the appropriate JVC Factory Service Center as listed above.

Don't service it yourself.

CAUTION

*To prevent electrical shock, do not open the cabinet. No user serviceable parts inside.
Refer servicing to qualified service personnel.*

ACCESSORIES

*To purchase accessories for your JVC product, you may contact your local JVC Dealer.
Or from the 48 Continental United States call toll free : 800-882-2345*



LIMITED WARRANTY AUDIO-2

JVC COMPANY OF AMERICA warrants this product and all parts thereof, except as set forth below ONLY TO THE ORIGINAL PURCHASER AT RETAIL to be FREE FROM DEFECTIVE MATERIAL AND WORKMANSHIP from the date of original retail purchase for the period as shown below. ("The Warranty Period.")

PARTS	LABOR
2YR	2YR

THIS LIMITED WARRANTY IS VALID ONLY IN THE FIFTY(50) UNITED STATES, THE DISTRICT OF COLUMBIA AND IN COMMONWEALTH OF PUERTO RICO.

WHAT WE WILL DO:

If this product is found to be defective, JVC will repair or replace defective parts at no charge to the original owner. Such repair and replacement services shall be rendered by JVC during normal business hours at JVC authorized service centers. Parts used for replacement are warranted only for the remainder of the Warranty Period. All products and parts thereof may be brought to a JVC authorized service center on a carry-in basis except for Television sets having a screen size 25 inches and above which are covered on an in-home basis.

WHAT YOU MUST DO FOR WARRANTY SERVICE:

Return your product to a JVC authorized service center with a copy of your bill of sale. For your nearest JVC authorized service center, please call toll free: (800)537-5722.

If service is not available locally, box the product carefully, preferably in the original carton, and ship, insured, with a copy of your bill of sale plus and letter of explanation of the problem to the nearest JVC Factory Service Center, the name and location of which will be given to you by the toll-free number.

If you have any questions concerning your JVC Product, please contact our Customer Relations Department.

WHAT IS NOT COVERED:

This limited warranty provided by JVC does not cover:

1. Products which have been subject to abuse, accident, alteration, modification, tampering, negligence, misuse, faulty installation, lack of reasonable care, or if repaired or serviced by anyone other than a service facility authorized by JVC to render such service, or if affixed to any attachment not provided with the products, or if the model number or serial number has been altered, tampered with, defaced or removed;
2. Initial installation and installation and removal for repair;
3. Operational adjustments covered in the Owner's Manual, normal maintenance, video and audio head cleaning;
4. Damage that occurs in shipment, due to act of God, and cosmetic damage;
5. Signal reception problems and failures due to line power surge;
6. Video Pick-up Tubes/CCD Image Sensor, Cartridge, Stylus(Needle) are covered for 90 days from the date of purchase;
7. Accessories;
8. Batteries (except the Rechargeable Batteries are covered for 90 days from the date of purchase);

There are no express warranties except as listed above.

THE DURATION OF ANY IMPLIED WARRANTIES, INCLUDING THE IMPLIED WARRANTY OF MERCHANTABILITY, IS LIMITED TO THE DURATION OF THE EXPRESS WARRANTY HEREIN.

JVC SHALL NOT BE LIABLE FOR THE LOSS OF USE OF THE PRODUCT, INCONVENIENCE, LOSS OR ANY OTHER DAMAGES, WHETHER DIRECT, INCIDENTAL OR CONSEQUENTIAL (INCLUDING, WITHOUT LIMITATION, DAMAGE TO TAPES, RECORDS OR DISCS) RESULTING FROM THE USE OF THIS PRODUCT, OR ARISING OUT OF ANY BREACH OF THIS WARRANTY. ALL EXPRESS AND IMPLIED WARRANTIES, INCLUDING THE WARRANTIES OF MERCHANTABILITY AND FITNESS FOR PARTICULAR PURPOSE, ARE LIMITED TO THE WARRANTY PERIOD SET FORTH ABOVE.

Some states do not allow the exclusion of incidental or consequential damages or limitations on how long an implied warranty last, so these limitations or exclusions may not apply to you. This warranty gives you specific legal rights and you may also have other rights which vary from state to state.

JVC COMPANY OF AMERICA
DIVISION OF JVC AMERICAS CORP.

1700 Valley Road
Wayne, NJ 07470

REFURBISHED PRODUCTS CARRY A SEPARATE WARRANTY, THIS WARRANTY DOES NOT APPLY. FOR DETAILS OF REFURBISHED PRO DUCT WARRANTY, PLEASE REFER TO THE REFURBISHED PRODUCT WARRANTY INFORMATION PACKAGED WITH EACH REFURBISHED PRODUCT.

For customer use:

Enter below the Model No. and Serial No. which is located either on the rear, bottom or side of the cabinet. Retain this information for future reference.

Model No.: _____

Serial No.: _____

Purchase date: _____

Name of dealer: _____

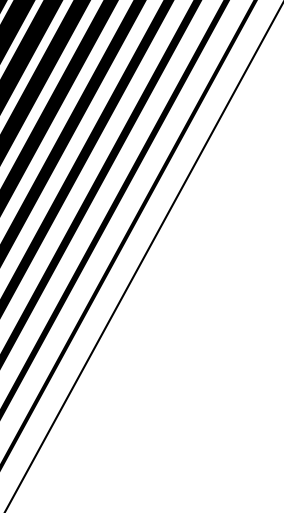

JVC
VICTOR COMPANY OF JAPAN, LIMITED